



DX 17

LOS ANGELES

CALI

GBN

TABLE OF CONTENTS

1	PLANNING	3	TOURS	6	TAKEAWAYS
2	GBBN PROJECT	4	TALKS		
		5	FUN		



In 2015, the first GBBN Design Expedition (DX) ventured to Philadelphia. The buildings we toured included the Barnes Foundation, the University of Pennsylvania, and Wharton Esherick's House, designed by Louis Kahn. DXers worked to evolve Our Guiding Principles and crystallize GBBN's mission, vision, and purpose.

In 2016, we ventured to Toronto. We visited Bridgepoint Hospital, Ryerson University, and The Sharp Centre by Will Alsop among others. DXers engaged in a series of precisely crafted exercises focusing on themes of Informed Form and Reflection vs. Reaction.

[In 2017, we descended on Los Angeles. Turn the page and let the story unfold...](#)

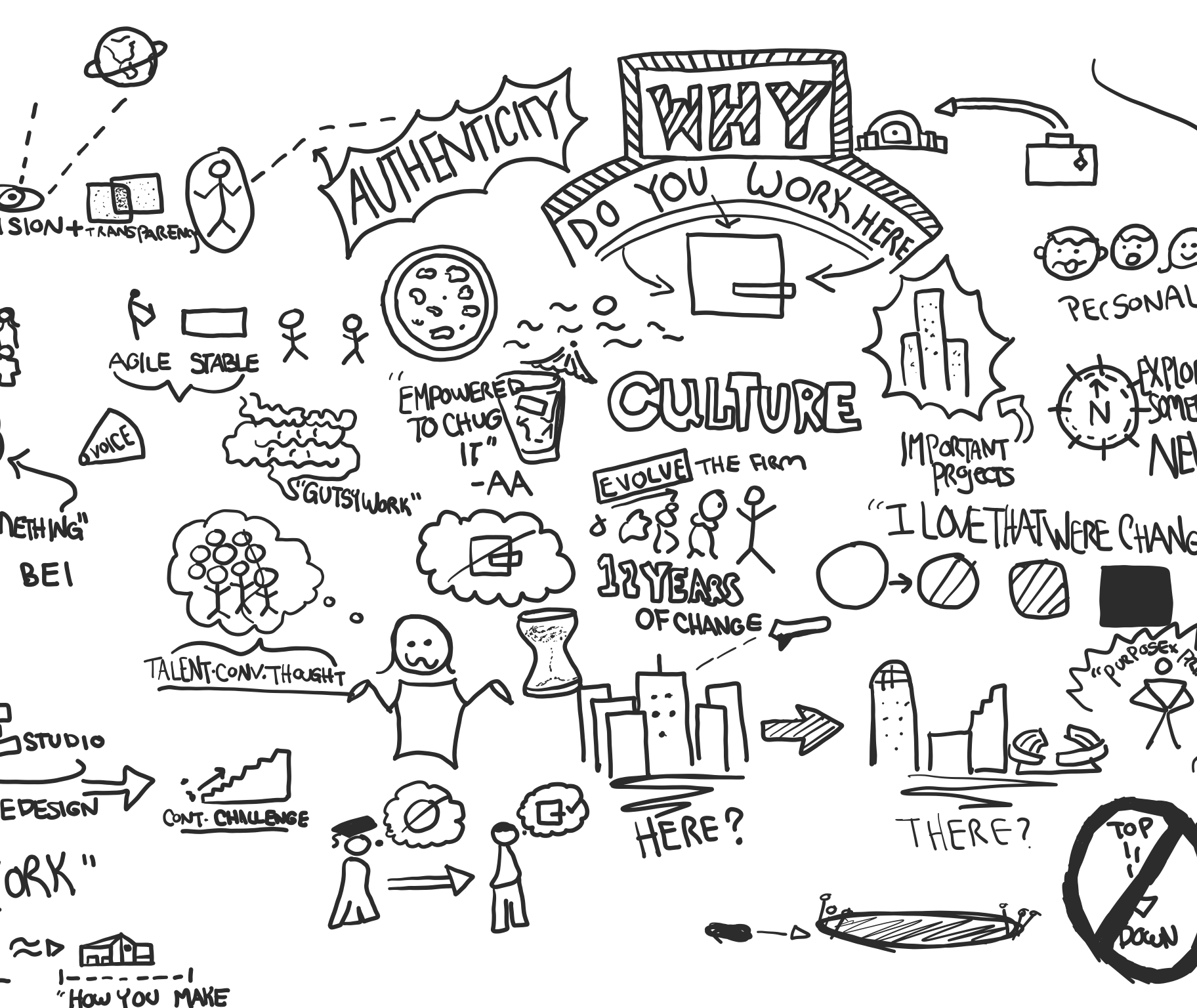

1 Planning



BOLD & BEYOND

In LA, we explored what it takes to **be bold and dream big**— physically and intellectually; to question courageously and practice change in our own design vision. Our research specimens? High profile projects that took big risks and helped define architecture's heroic role in a city that's still growing up.

PEOPLE



Aaron Anderson
Brooke Behnfeldt
Chad Burke
Nick Cates

Anne Chen
Ivan Cheung
Daniel Colvard
Blaise Durio

Jason Groneck
Steve Kenat
Marcie Kinney
Mike Lied

Danny Luegering
Amanda Markovic
Amy Mees
Greg Pinter

Matt Plecity
Matthew Schottelkotte
Anne Schwab
Steph Shroyer

Cassidy Staver
Jay Studer

AGENDA

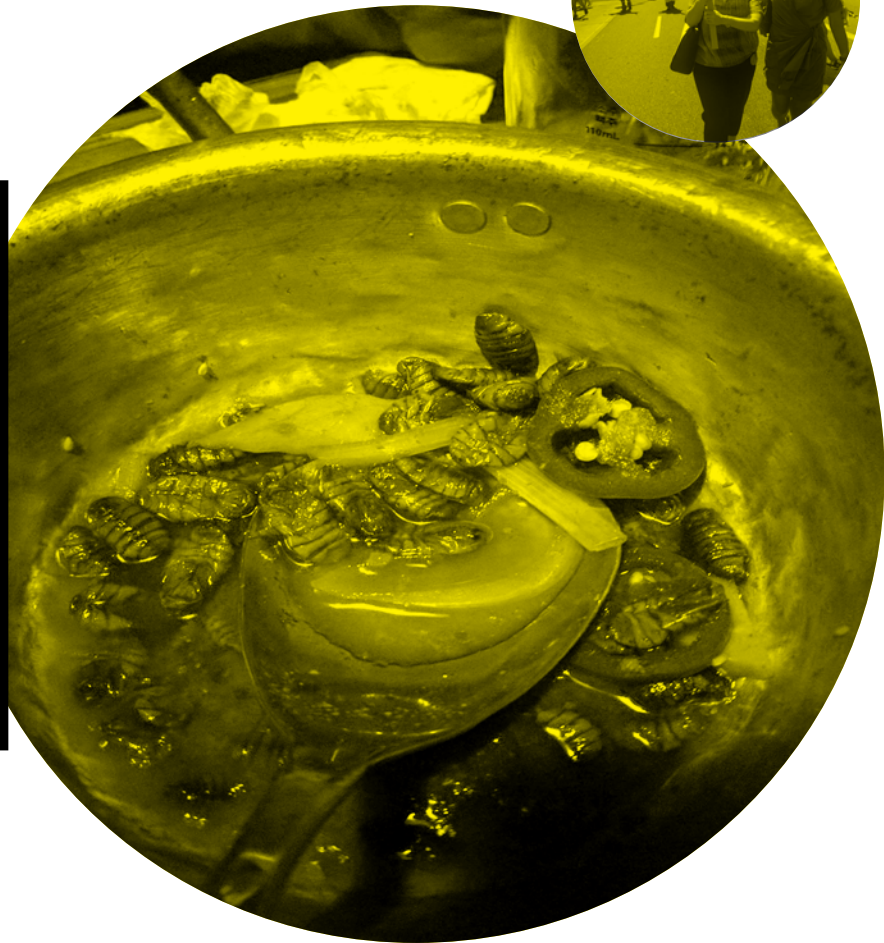

SUNDAY

Jason Groneck rides to airport alone w/ two bottles of bourbon

DX17 kickoff at Ace Hotel Downtown Los Angeles
Building presentations + project GBBN

Dinner

MONDAY

Project GBBN report outs
Design Topic: Design vision and language

Lunch
Marcie joins a protest

Cathedral of Our Lady of the Angels

Dinner
Some people discover love for panna cotta
Some people eat silkworm larvae soup

TUESDAY

Discuss Cathedral visit
Design Topic: Poetic problem solving

Lunch
Tour the Broad

Chad Burke enjoys "skeetball"

Dinner
Aaron Anderson loses his bag. Matthew and Jason drink the Bourbon

WEDNESDAY

ACE Theatre tour // Discuss Broad visit

Tours:
Emerson College LA
Los Angeles Museum of the Holocaust Museum
STAR Apartments- Skid Row Housing
Schindler House

Design Topic: Design Equity

Dinner
Bowling
Amanda loses her bag



THURSDAY

Walt Disney Concert Hall Tour (self-guided)

Small Group Report on Los Angeles Museum of the Holocaust and Walt Disney Concert Hall
Design Topic: Technology and how it shapes our vocabulary

Dinner

Airport Departure

FRIDAY

Jason Groneck returns home 12 hours late, without the bourbon

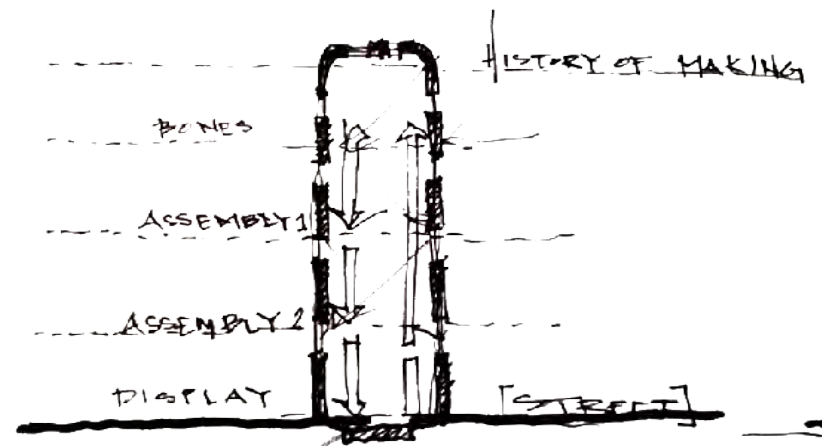
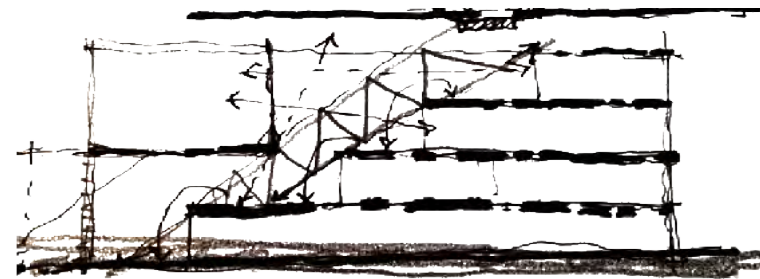
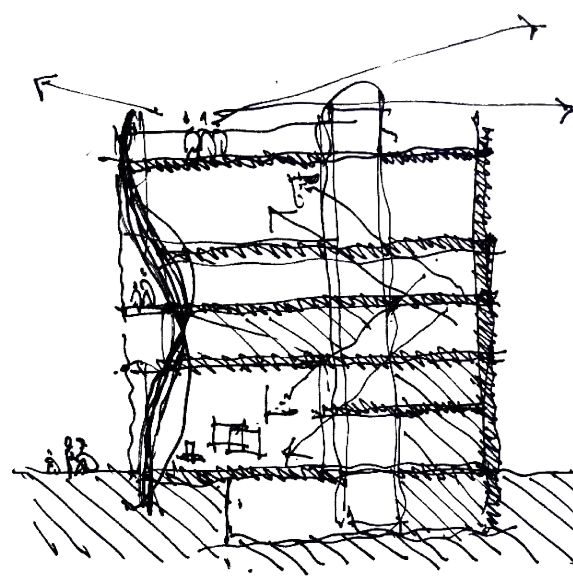
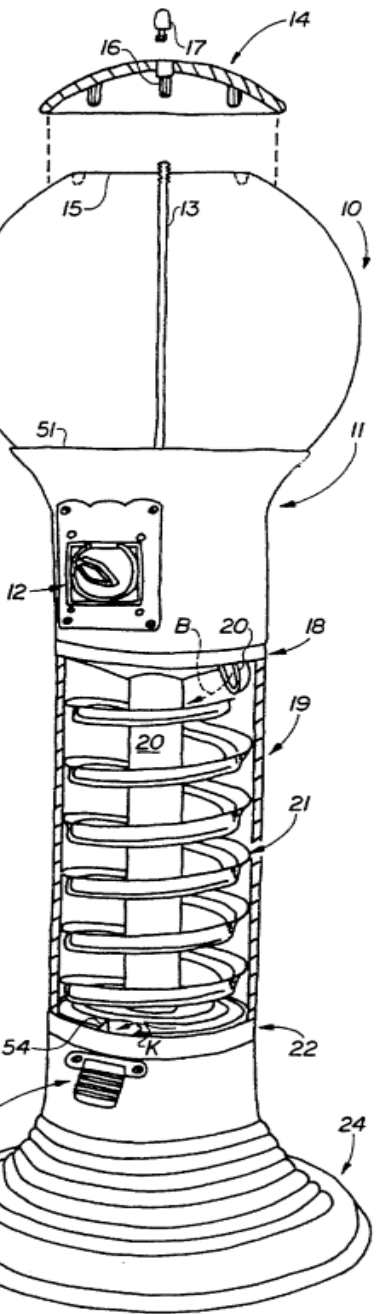

GBBN Project

2

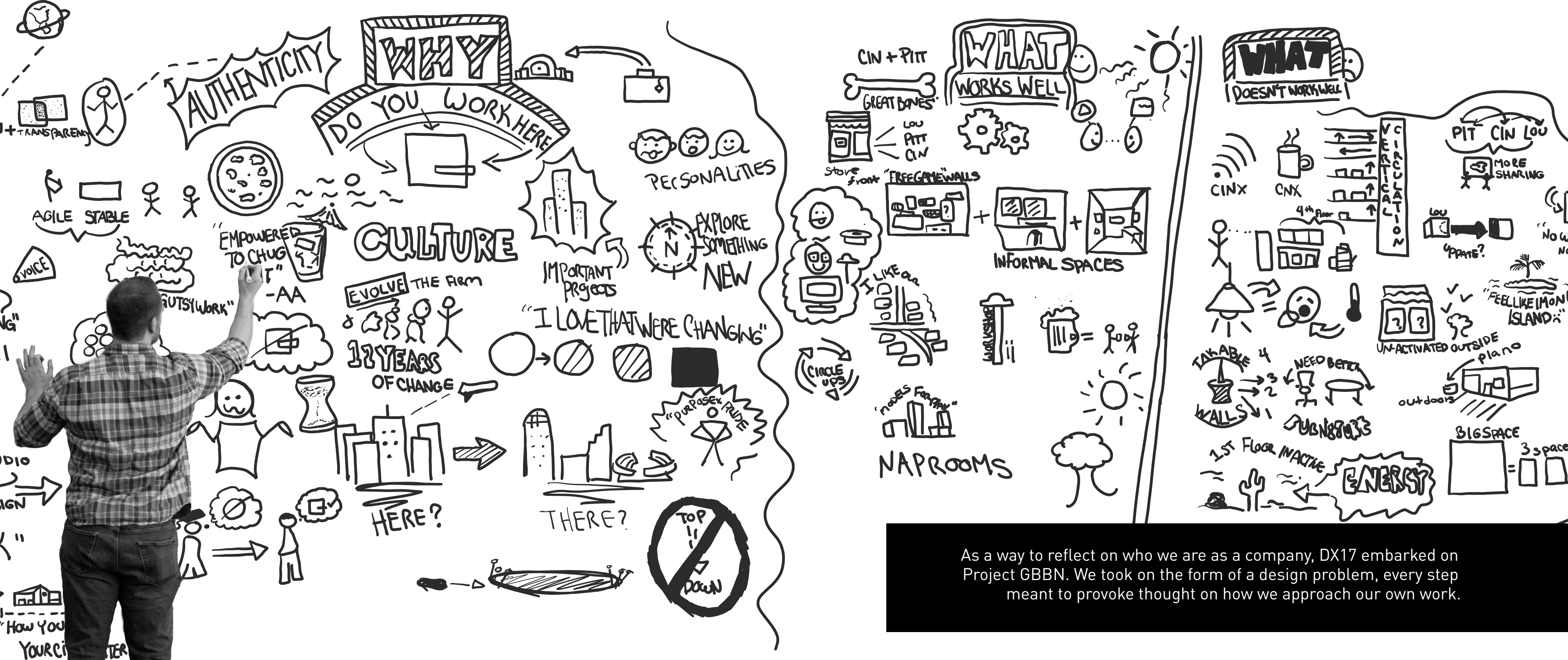

As a way to reflect on who we are as a company, DX17 embarked on Project GBBN. We took on the form of a design problem, every step meant to provoke thought on how we approach our own work.

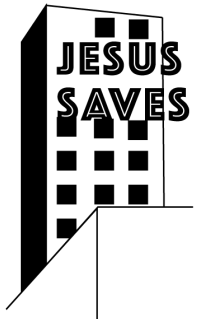

01 ACE HOTEL DOWNTOWN
LOS ANGELES & THEATRE

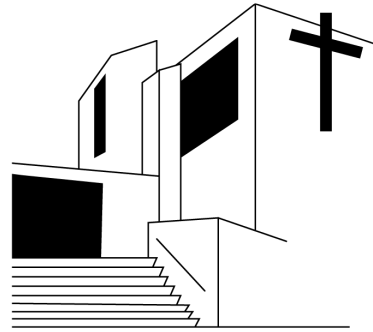

02 CATHEDRAL OF OUR
LADY OF THE ANGELS

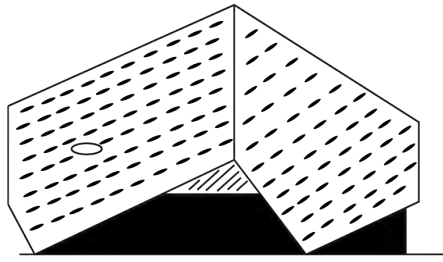

03 THE BROAD MUSEUM

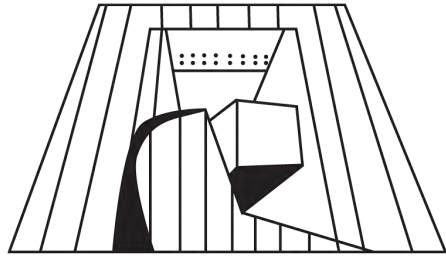

04 EMERSON COLLEGE, LA

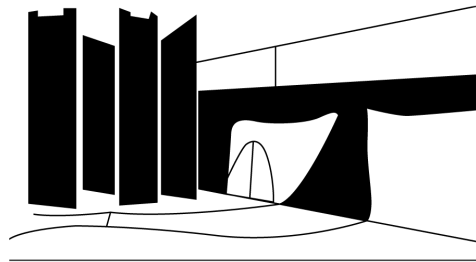

05 LOS ANGELES MUSEUM OF
THE HOLOCAUST

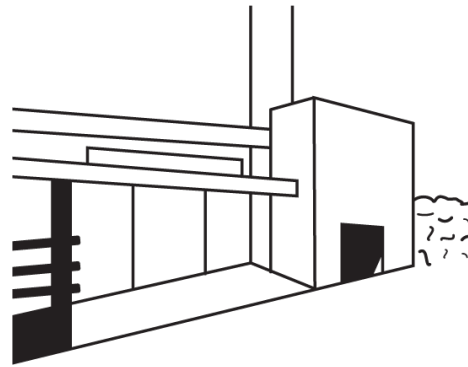

06 RUDOLPH M. SCHINDLER
HOUSE AND STUDIO

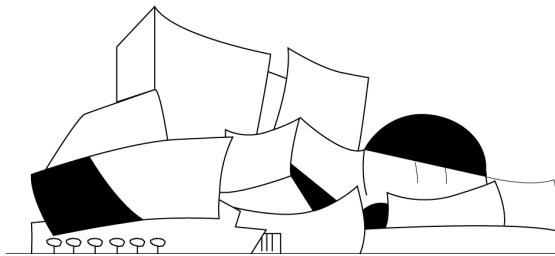

07 WALT DISNEY CONCERT HALL

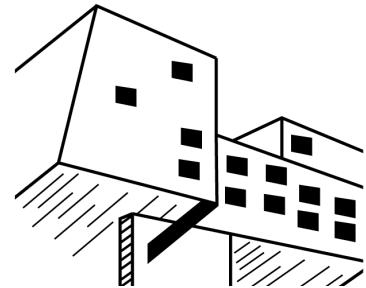

08 SKID ROW HOUSING - STAR APARTMENTS

Tours 3

// ACE HOTEL & THEATRE DOWNTOWN LOS ANGELES

What Others have said:

"Downtown Los Angeles is undergoing its largest construction boom in modern times — an explosion juiced by foreign investment that's adding thousands of residences, construction jobs, and a multitude of shops and restaurants."

—Brett Martin, *GQ Magazine*

Our take:

Two early entrants into this bolder, livelier downtown scene are the Ace Hotel and the neighboring Theatre on Broadway. Curated grit and a prime location made these a perfect home away from home for us to inhabit the scene, examine our convictions, and convene around ideas that encourage bold design vision.

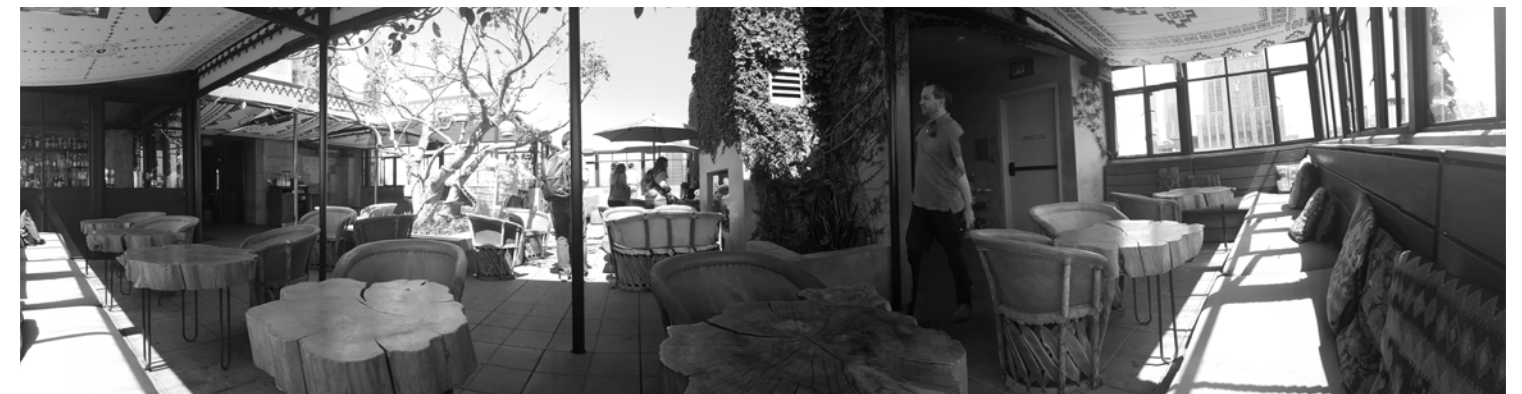
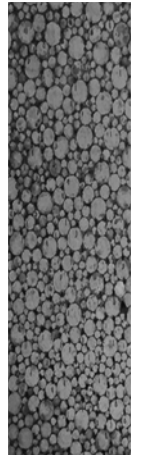

// CATHEDRAL OF OUR LADY OF THE ANGELS

What others have said:

“The grandeur of its interior will instantly make it the city’s most glorious public space. In its beauty, it is the equal of the Getty Museum’s celebrated glass rotunda. In its heroic scale, it embodies LA’s slow shift from a place of stubborn individualism to one that is struggling to find its communal identity.”

—Nicolai Ouroussoff, *Los Angeles Times*

Our take:

Intended as a comment on timeless ideas of light and heaviness in its forms and structure, the Cathedral also addressed the freeway as the true “public square” of LA. Moneo’s design seems to stitch together past and present through a journey to quiet that’s hard to find today.

The plan diagram delivered on its mission to protect and provide rest within soaring concrete forms bathed in ethereal light from above. It also seemed to isolate and detach visitors from the city, leaving a question about how bold forms can excite but also overpower experience. There were also some key details not fully resolved (massive over-wrought lighting fixtures hanging in the sanctuary or religious artwork in conflict with the modern forms of the architecture) that often distracted from the larger experience.



// THE BROAD MUSEUM

What others have said:

"It's arguably the most significant new building - both culturally and architecturally - in the city since its neighbor, Frank Gehry's Disney Hall, opened in 2003."

—Sam Lubell, *Wallpaper*

Our take:

We expected something inspiring at The Broad. We were all excited to see this building, intrigued and impressed by the expression of the facade and the simple part of a facade that is draped over a gallery with a vault that separates the first and third floors, which acts as a storage facility for the artwork that is not currently hanging. Yes, the facade was beautiful, both inside and out, but it was a one liner, they built the diagram. Becoming a decorated box.

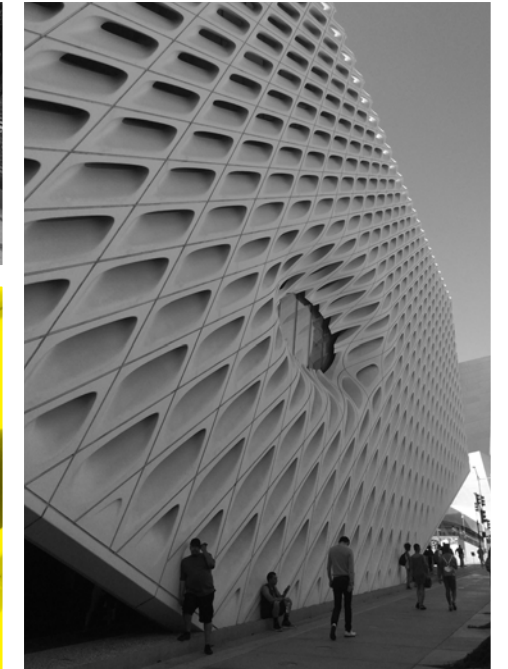
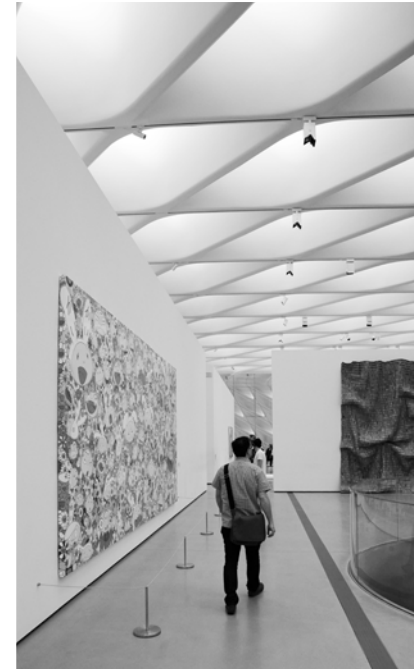

// EMERSON COLLEGE, LA

What others have said:

“The first question about Emerson College’s hulking new Hollywood campus on Sunset Boulevard, designed by Thom Mayne and the Culver City firm Morphosis, is simply what to call the architectural box in which it comes packaged. As you approach it heading east or west on Sunset, the \$110-million building — one of the first really ambitious pieces of architecture to be finished in Los Angeles since the recession — looks to be an unadorned 10-story cube wrapped in metal panels and a gridded pattern of sunshades....You think of the alien popping out of Sigourney Weaver’s stomach.”

—Christopher Hawthorne, *Los Angeles Times*

Our take:

“Exciting and unexpected” described our much-anticipated tour of Emerson College. “Unresolved and complicated” also described it. Emerson College’s Hollywood presence as a film/theatrical extension of their larger east coast campus was definitely captured in a bold and novel form by Morphosis.

The elevated, framed views over the city and courtyard-centric massing of the student housing all fashioned within an exciting use of façade materials truly transformed our perception of the city and drove a powerful story about the student experience. Small oddities and a bit of detachment from Sunset Avenue didn’t ultimately detract from the sense that the project achieved a powerful, unique vision of what a higher education experience can be.

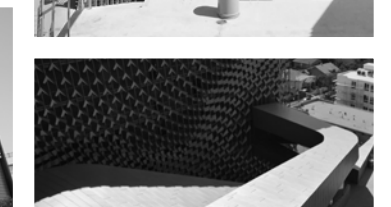
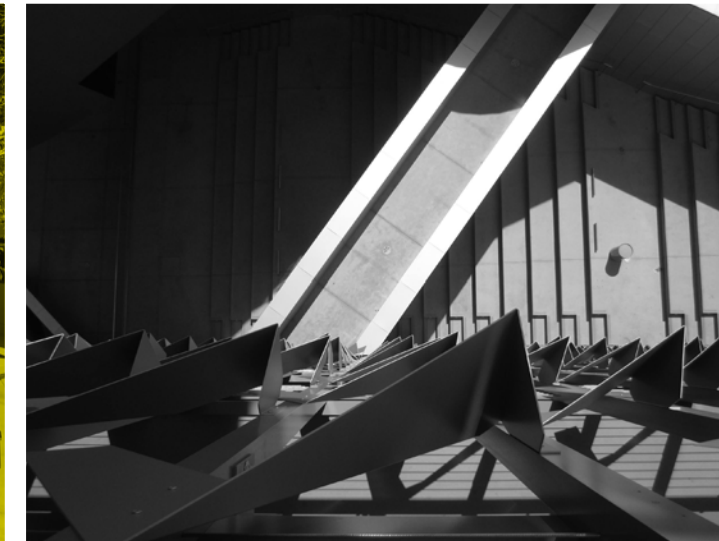
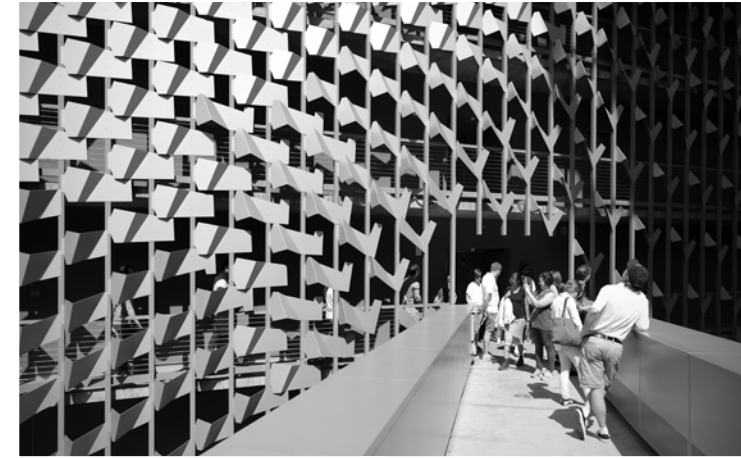

// LOS ANGELES MUSEUM OF THE HOLOCAUST

What others have said:

"The 32,000-square-foot building, designed by Belzberg Architects, is radically self-effacing and, in a city designed for cars, weirdly easy to miss while driving past. It bears no evident symbols of its subject and is largely subterranean...As required by the city, the building hardly intrudes on the park. The problem is that this also puts out of sight the very thing the museum is supposed to bring to notice."

—Edward Rothstein, *The New York Times*

Our take:

It felt...rushed - like the architects had a concept twice the size of the building they were commissioned to build. Circulation was rightly employed as a tool to foster contemplation and reflection, which is certainly warranted by the gravity of the subject matter. Literally too much for the park to hold, the museum submerges itself, blurring the lines between inside and outside. Metaphorically, it harkens back to a time when people turned their heads, willfully ignorant to these atrocities.

The movement from darkness to light, traveling the time line of the holocaust as you submerge - the exhibits check all of the boxes. But inside of one large open volume—replete with the architects formal agenda—there was an inappropriate tension. It felt unfortunate that everything had to be crammed directly on top of one another, with no room to breathe as strong, individual statements. Unless you count the architect's statement - they made sure you understood that one.

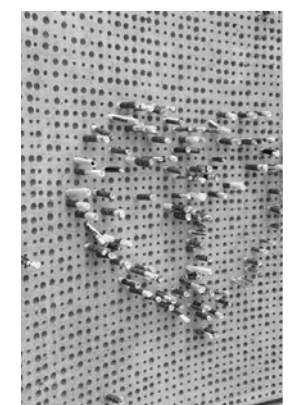
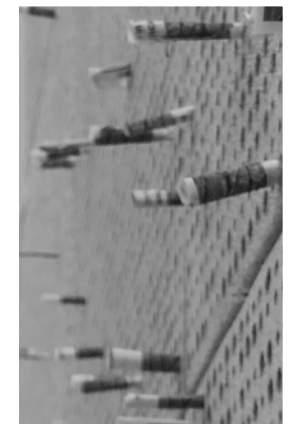

// RUDOLPH M. SCHINDLER HOUSE & STUDIO

What others have said:

“The Schindler House, designed by modern architect and Viennese émigré Rudolph M. Schindler, is considered one of the world’s first modern houses. It has influenced and inspired generations of architects worldwide. It redefined notions of public and private, and indoor and outdoor space; and broke new ground in the design and construction of the modern dwelling.”

—makcenter.org

Our take:

The allure of the Schindler House could not be avoided. A small group of us wanted to experience this architectural icon. We were impressed by the humility and simplicity of each individual space in the home, the careful, people-scale proportions, aesthetic material treatment, and the incorporation of landscape—these form the backdrop of the visionary couple who once lived here.



// WALT DISNEY CONCERT HALL

What others have said:

"Disney Hall may rank as the most effective answer to doubters, naysayers and grumbling critics a major American architect has ever produced. The building...responds to the lonely moonscape urbanism of Bunker Hill in downtown LA with a shimmering, canny gregariousness that spills down Grand Avenue in both directions."

—Berrin Chatzi Choussein, *World Architecture*

Our take:

We had pre-conceived perceptions colored by the controversy over the architect Frank Gehry, and his sculptural process. Many doubters going in came away surprised; the bold sculptural qualities of the form still delivered exciting spatial experiences (often bathed in unforeseen daylight) and connected graciously to the urban experience and history of Grand Avenue. A few of us snuck into the concert hall during a symphony rehearsal; our ears still thank us. Technical mastery + bold vision = transformative musical experience in a building of lasting impact.

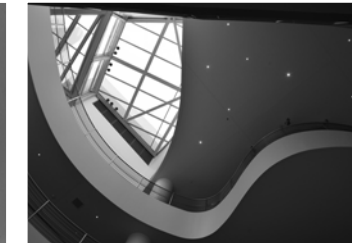
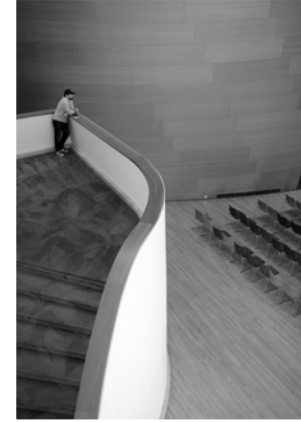

// SKID ROW HOUSING – STAR APARTMENTS

What others have said:

“The Skid Row Housing Trust (SRHT) was set up in the late 1980s to provide permanently supportive housing for formerly homeless individuals. Michael Maltzan Architecture has designed three new buildings for Skid Row Housing Trust over the last seven years...[including] Star Apartments. The formal virtuosity of each composition is Maltzan’s own special skill and they suggest that high architecture can give pleasure and dignity to all of us.”

—Niall McLaughlin, *The Architectural Review*

Our take:

While both the design and prefabrication of the Star Apartments are noteworthy, the who and the why of the story are what will always stick with us. It was in the community garden, where residents were making ceramic tiles and tending their plots where Mike Alvidrez of SRHT mentioned that “You can tell a lot about what someone thinks of you by the spaces they design for you.” This brought so many issues surrounding design equity to the forefront of our conversations and has changed how to think of public space.





You can tell an awful lot about what people think about you by the spaces they design for you.”

— Mike Alvidrez

Skid Row Housing- Star Apartments

OVER THE COURSE
OF THE EXPEDITION THE
TEAM ENGAGED IN MULTIPLE
DESIGN DISCUSSIONS TO
PROMOTE DISCOURSE + NEW
WAYS OF THINKING.

Talks

4

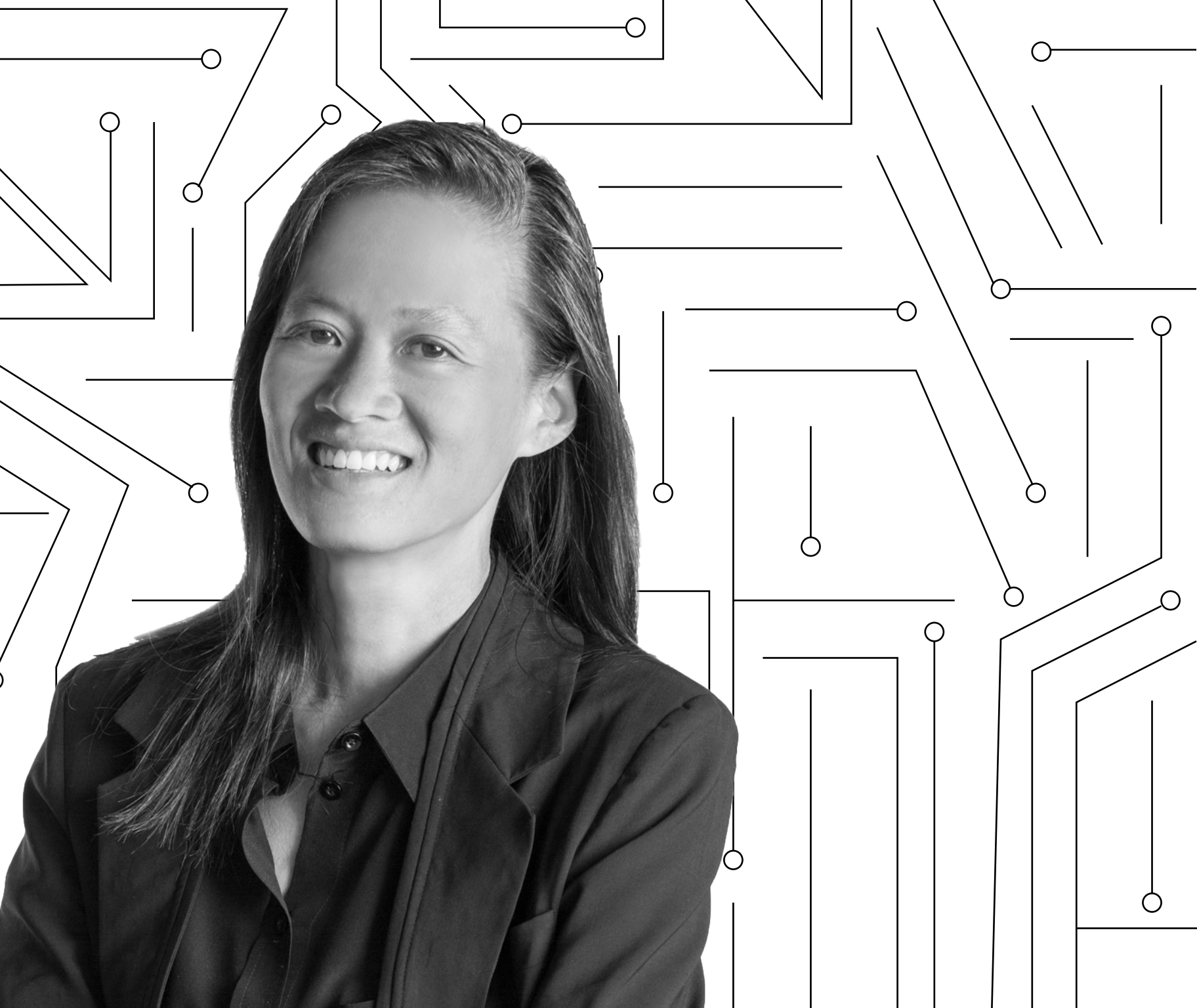

**“TECHNOLOGY AND
FABRICATION AS A WAY
TO MAKE THINGS.”**

— ANNE CHEN

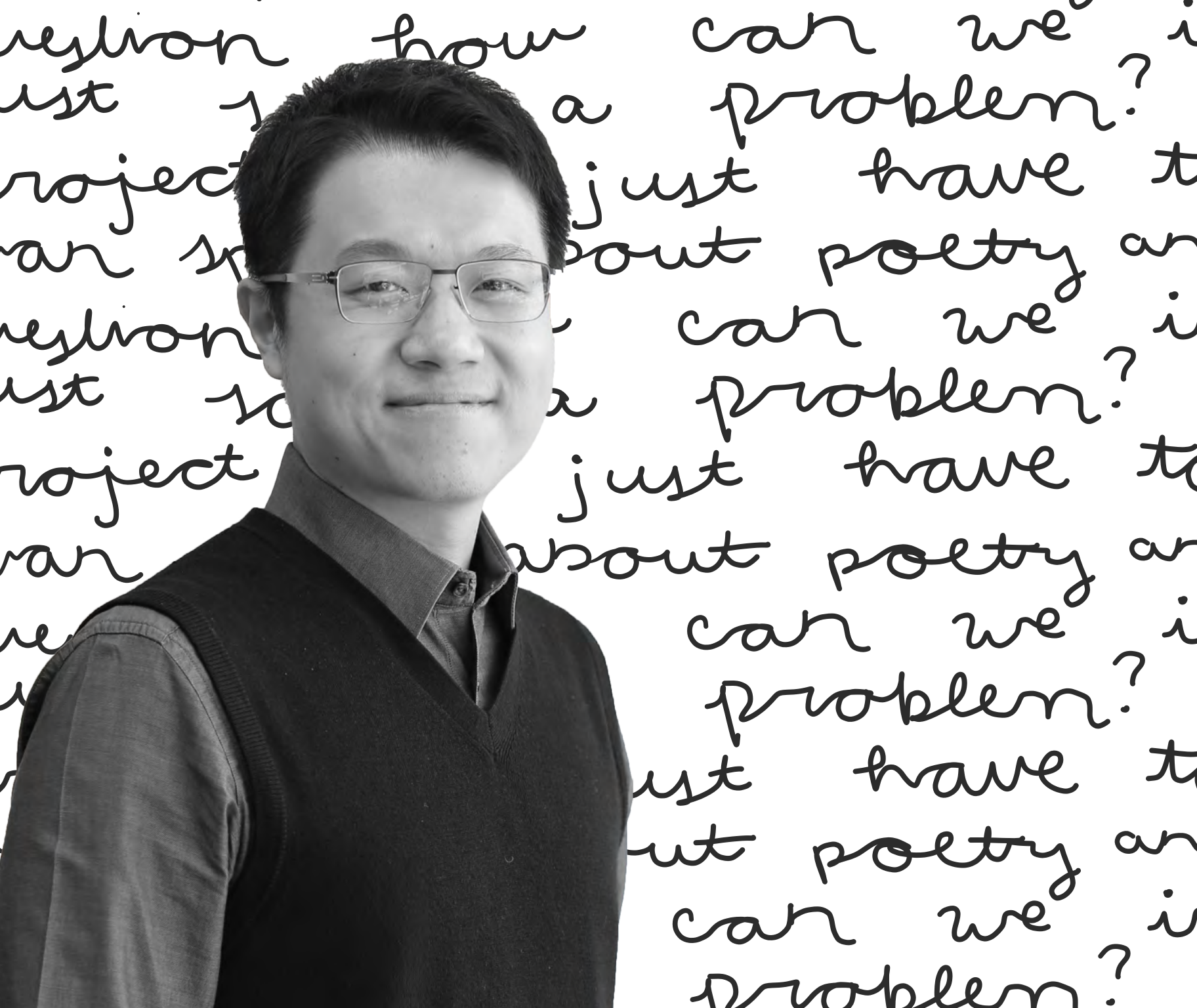

“POETIC PROBLEM SOLVING.
HOW CAN WE IMPACT POETICALLY,
NOT JUST SOLVE A PROBLEM?
THERE IS POETRY IN EVERY PROJECT,
WE JUST HAVE TO EXPOSE IT.”

— IVAN CHEUNG

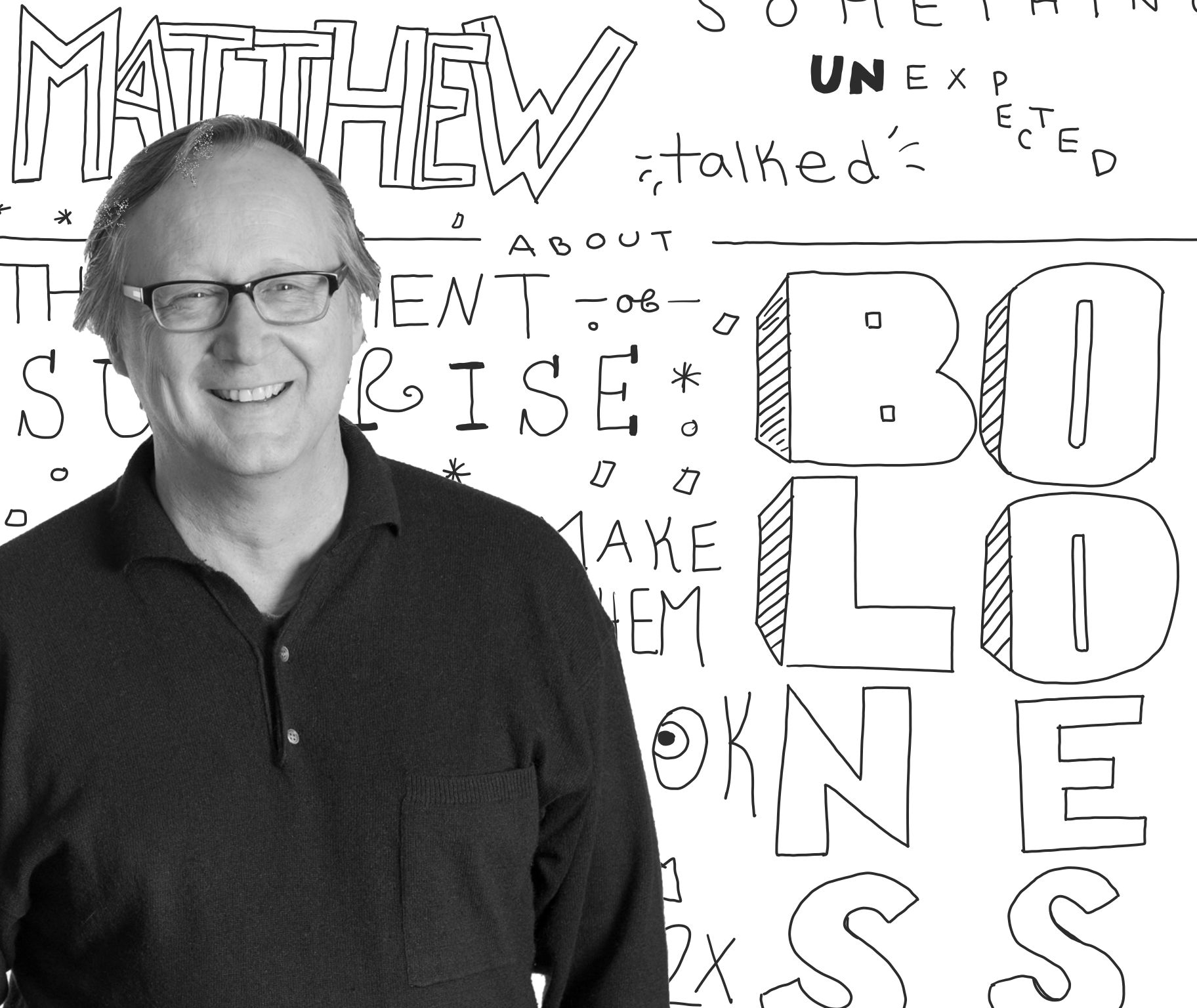

“BOLDNESS: THE ELEMENT OF SURPRISE. MAKE THEM LOOK TWICE. THOSE MOMENTS THAT MAKE PEOPLE DROP THEIR GUARD.”

— MATTHEW SCHOTTELKOTTE



[

]

Takeaways

6

“Transformative space
doesn’t come easily.
We have work to do.”

Intentionality gets personal.

“Ambitious design matters!”

“Let’s stretch ourselves to
create spaces that is beyond
what a client can imagine.”

“We’ve experienced
buildings whose design
people really fought for.
Let’s keep doing that.”

“Big things, important
ideas...are not realized
without questioning, without
dreaming and without
knowing what you’re willing
to fight for.”

“Our evolution needs...
the kind of dynamic,
committed, inspired people
of this group. It can’t rest in
the hands of only a few. ”

“Spend appropriate time in
this journey of getting to
authentic, meaningful ideas.”

“The unexpected (or poetic)
allows people to connect.”

“It is important
to practice change.”

“Authenticity in our
work is paramount.”

“You won’t make
great architecture without
a clear vision.”

DX17
LOS ANGELES

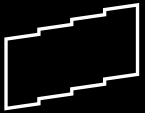

ENHANCE & EMPOWER

GBBN.COM