



PRE
FAB
LAB

(DIS) DESIGN ISSUES SERIES

DESIGN ISSUES SERIES (DIS)

The Design Issue Series is GBBN's annual collaborative exhibition between our offices. The goal of DIS is to take a step back, explore, understand, and present a specific topic in a new light to foster lively and creative public discourse .



Why Pre Fab Lab.....	05
History + Precedents	07
Inside the Lab.....	11
1. Cincinnati: Mapping the Module.....	13
2. Louisville: Technical Techniques.....	31
3. Pittsburgh: Sites & Strategies.....	37
In Action	55
4. Vanke Xinyuan	57
5. Tree Pittsburgh	59
6. St. Ambrose Apartments	61
7. The Edge On 4	63
Exhibit	65
Takeaways	67



WHY PRE FAB LAB

To remain diverse, vibrant, and resilient, cities have to be affordable.

Cities across the country are facing critical shortages in affordable housing. In Pittsburgh for example, a 2016 affordable housing task force report revealed a shortage of 17,000 housing units for the city's lowest income earners*.

Modular prefabrication (factory made components that are assembled at a building site) may address this housing shortfall. Prefabricating homes can result in a 30% reduction in build time and allows for assembly during the harsh winter months when conventional exterior construction usually halts. In addition to the gain in time, modules are manufactured in a controlled environment providing a higher level of quality and precision, reducing construction waste.

At GBBN, we've been exploring the possibilities of prefabrication for over a decade. We saw DIS 2017 as an opportunity to dive deeper into our experience working with prefab and explore how the benefits of modular construction can be leveraged to create affordable, transformative, and equitable communities.

*Source: City of Pittsburgh Affordable Housing Task Force, 2016 Report

HISTORY



1624
Great House, Cape Ann
 The first known prefab, a panelized woodhouse, is shipped from England to Massachusetts as housing for a fishing fleet.



1949
Wichita House A Dymaxion prefabricated, single family dwelling unit designed by Buckminster Fuller.



2005
Desert House A decade of renewed interest in prefabs kicks off: Before long, Rocio Romero's popular LV, Michelle Kaufmann's Glidehouse and Breezhouse, and Marmol Radziner's Desert House are launched and well received.

1624

1850

1949

1972

2005

2008

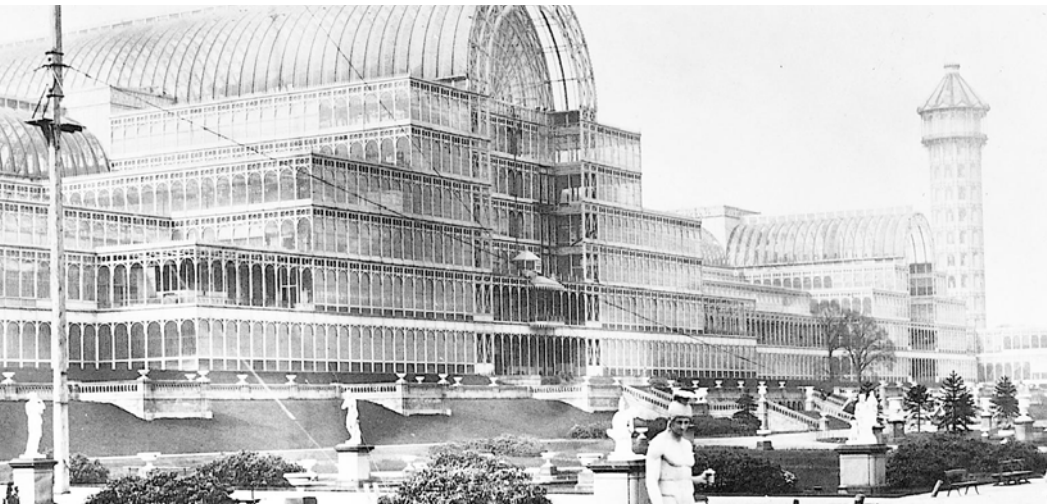

1850
Crystal Palace, London
 The huge, modular, wood, glass, and iron structure was originally erected in Hyde Park, London to house the Great Exhibition of 1851, which showcased the products of many countries throughout the world.



1972
Nakagin Capsule Tower
 A mixed-use tower completed in just 30 days, designed by architect Kisho Kurokawa and located in Shimbashi, Tokyo, Japan.



Room within the tower



2008
MOMA Exhibit: Home Delivery: Fabricating the Modern Dwelling
 New York's Museum of Modern Art mounts a landmark retrospective of prefabs.

PRECEDENTS



INSIDE THE LAB

Through charrettes (brainstorming sessions) with GBN, industry peers, and members of the public, we explored prefabrication at three scales:

1. Mapping the Module
2. Technical Tactics
3. Site & Strategies.

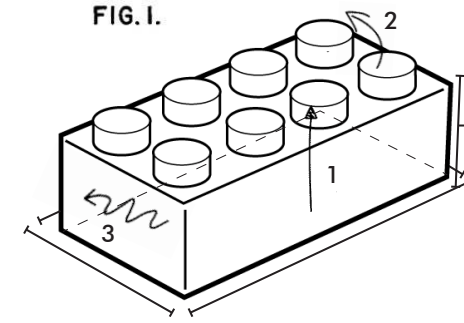

MAPPING THE MODULE

The Cincinnati team invited members of the local building community and explored the spatial limits of prefabricated boxes and investigated how to optimize living space.

COMMUNITY AS YOUR LIVING ROOM

Individual units don't have to provide every imaginable feature since you can walk down the street and find cafes, theaters, parks, and shops. Those public amenities take a lot of pressure off the "tiny house." This unit is a modular, low-cost, "live small" alternative to traditional single or multi-unit housing on infill lots in non-gentrified urban neighborhoods.

It's a micro home-tower, made of modules containing living space, bedroom, bathroom, and kitchenette. Each module is between 450 -750 square feet. Residents have access to a communal patio, gardens, and their own front door.

Units may be rented or owned, and lots can be shared to build community. Configurations are designed to maximize views, daylight, natural ventilation, and green space. Units are super insulated and sealed under factory conditions, reducing waste and speeding assembly on-site. Mass customization means a selection of extras—like balconies and window boxes—can be added.

...modular, low-cost, "live small" alternative to traditional single or multi-unit housing

Team: Blaise Durio, Renee Martin, Dan Shapiro, Matthew Schottelkotte, Jessica D'Angelo

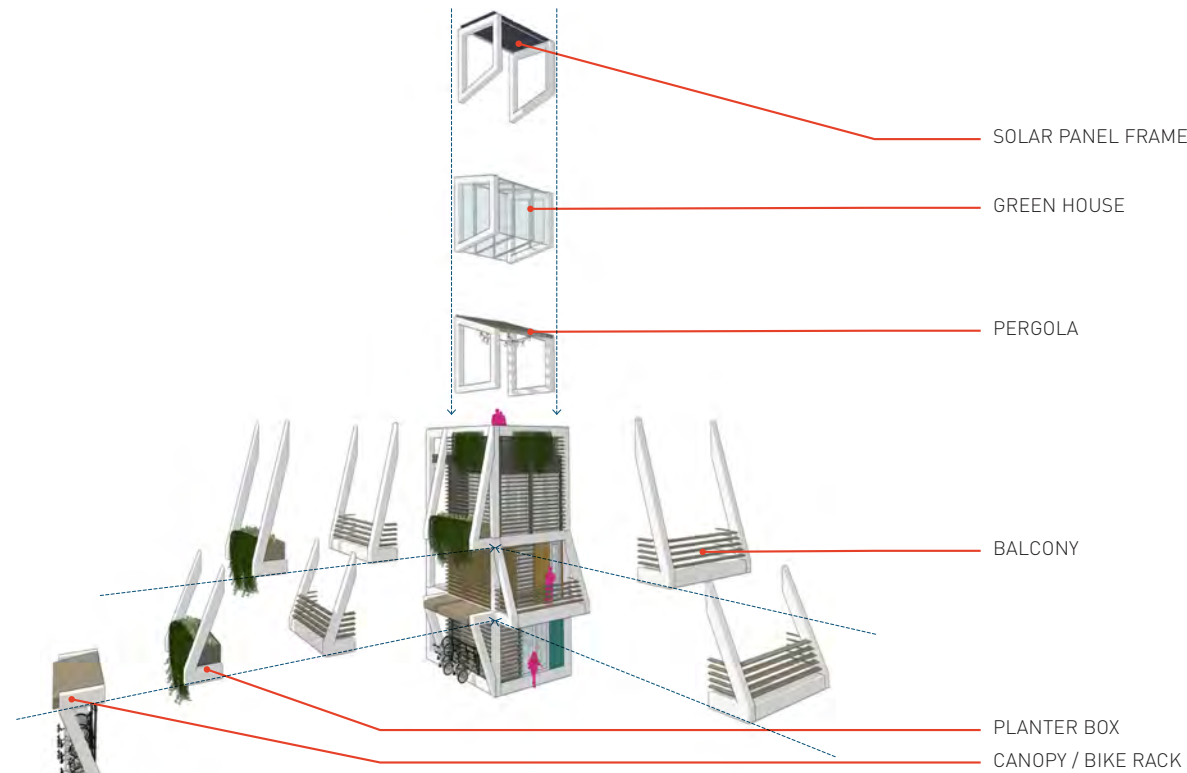

YU-DU (Young Urban Dwelling Unit) MODULES

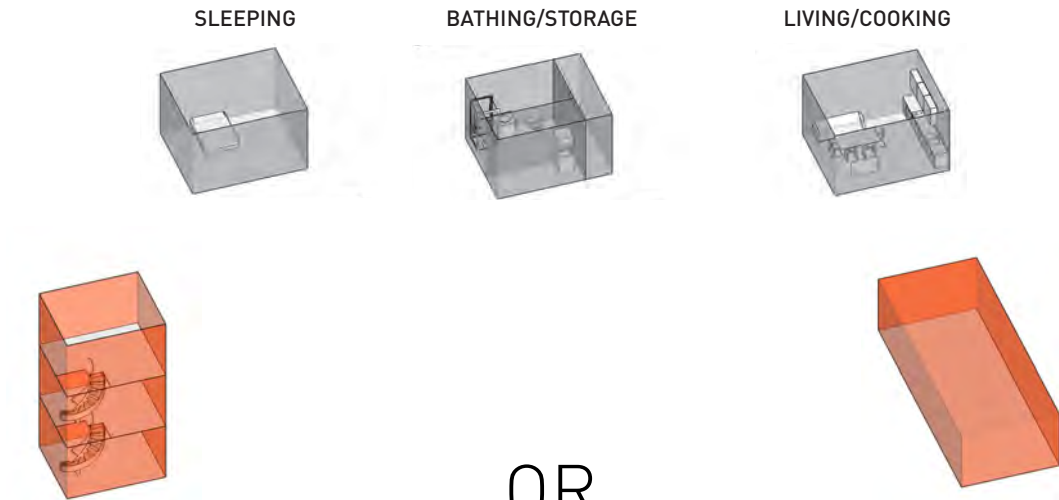

STACKED MODULES
(17 FRONT DOORS)

TYPICAL MICRO-UNIT
(1 FRONT DOOR)

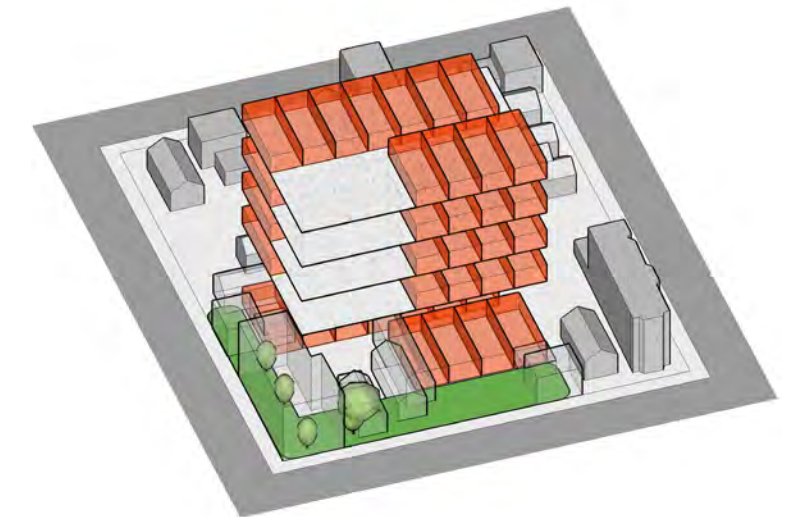
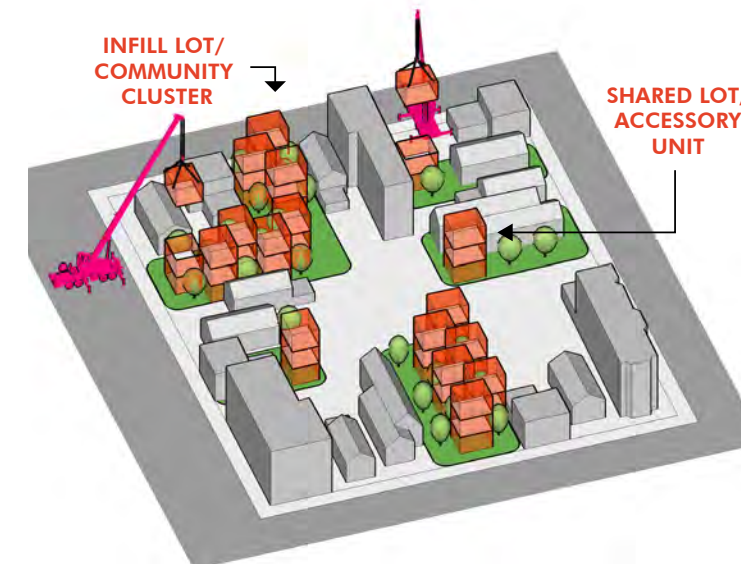

MODULE & DESIGN

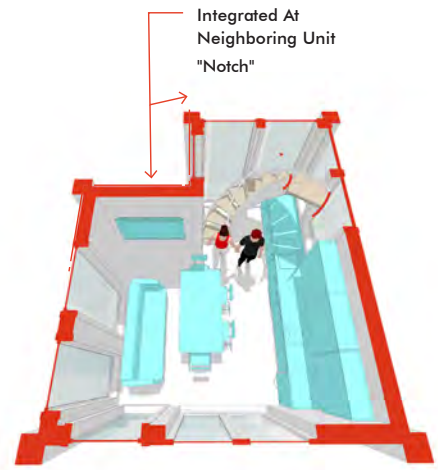

Living_Ground Floor

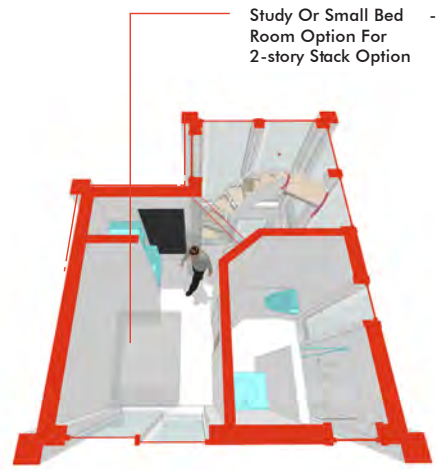

Bathing/storing/working_Second Floor

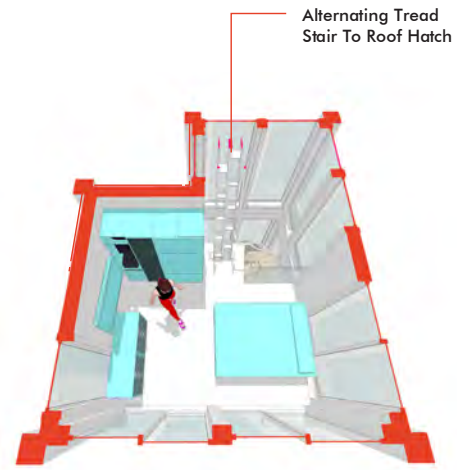

Sleeping_Third Floor

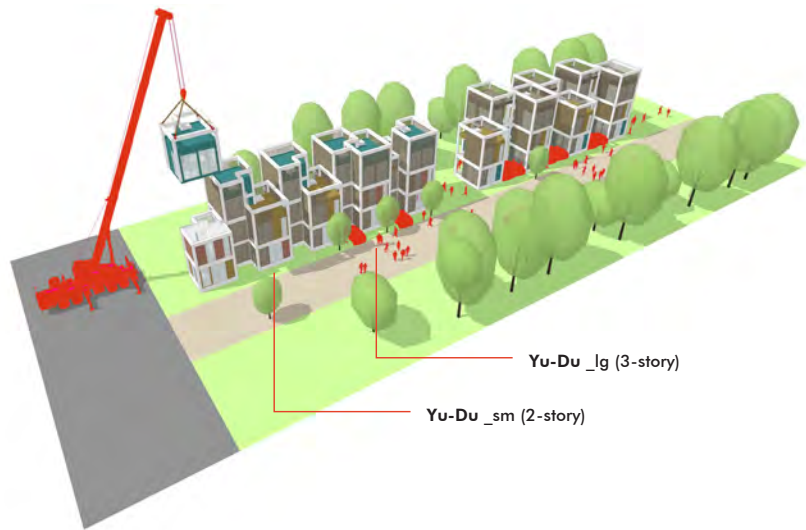

Yu-Du _lg (3-story)

Yu-Du _sm (2-story)

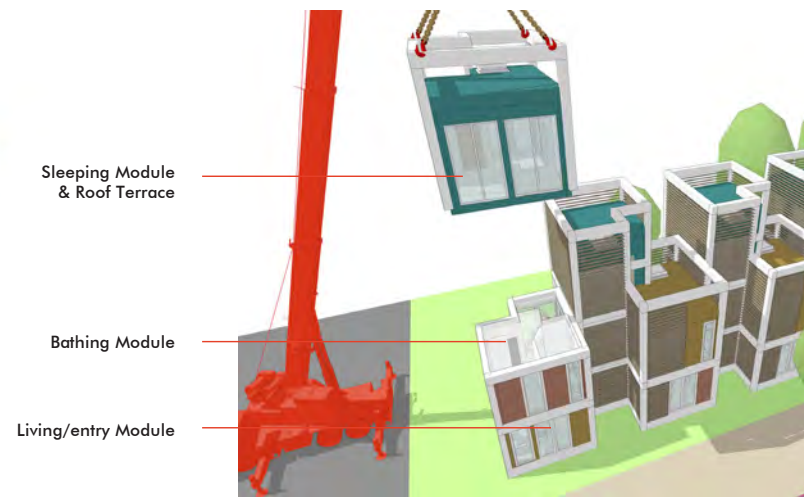

Sleeping Module & Roof Terrace

Bathing Module

Living/entry Module



AFFORDABLE FAMILY HOUSING

The single unit module was originally designed for a single mother and two children. The design team proposed that over time the module would need to be able to expand to accommodate growing families. Therefore, an additional unit was added to the base module, creating a super unit.

This super unit was designed so that it could be aggregated in both plan and section, creating a dynamic range of spatial constructs as it begins to populate across a field. The spatial constructs created by the systematic aggregation of the base unit and super unit allow for the potential of shared courtyards, private terraces, and green spaces that can be placed vertically throughout the building.

Team: Steve Kenat, Elizabeth Schmidt, Aaron Fritsch, Alex Cheplowitz

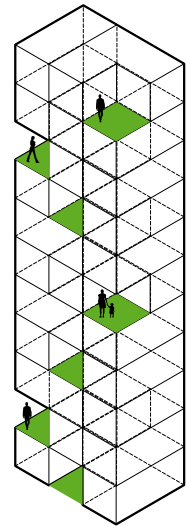

Super Unit Stacked Plan
Combinations Only

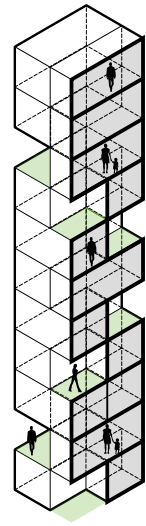

Axonometric Section

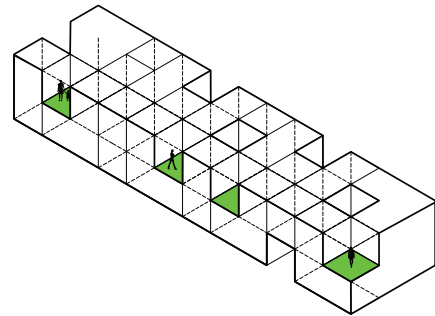

Super Unit Stacked Plan
and Section Combinations

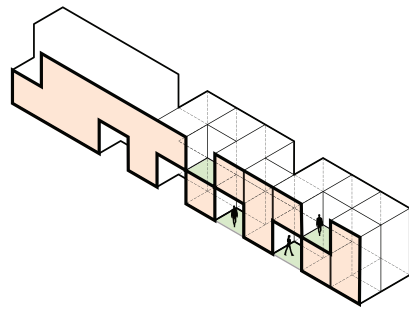

Axonometric Section

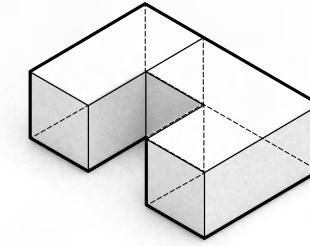

Unit + Super Unit

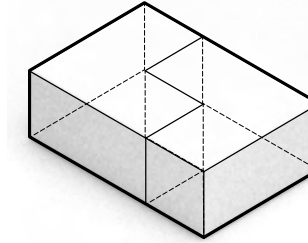

Super Units Interlocked

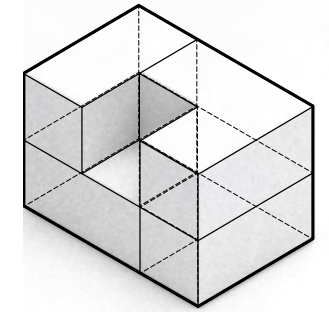

Super Unit Interlocked
+ Unit + Super Unit
Stacked

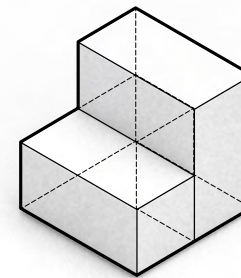

Unit + Super
Unit Rotated

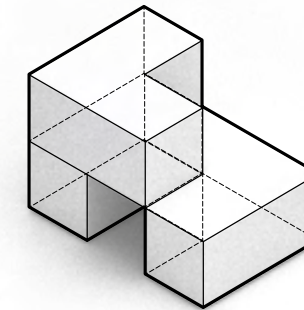

Unit + Super Unit
+ Super Unit Stacked

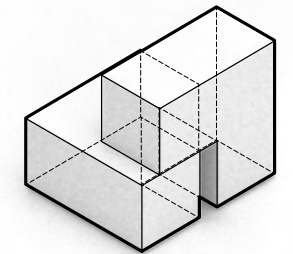

Super Unit +
Rotated Super Unit

The design team proposed that over time the module would need to be able to expand to accommodate growing families.

UNIT, PLAN, & SECTION COMBINATIONS

UNIT

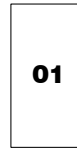

Unit

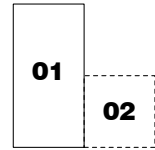

Optional Addition

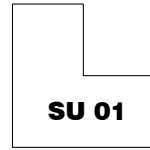

Super Unit

PLAN COMBINATION

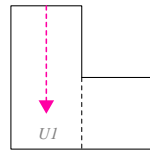

Unit

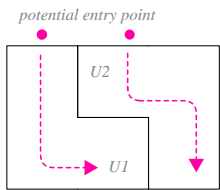

Interlocking Units

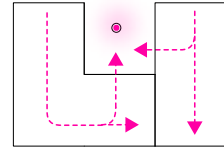

Potential Shared Space

SECTION COMBINATION

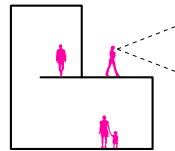

Potential Views Out

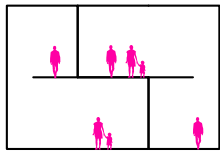

Interlocking Units

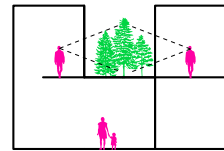

Potential Shared Space

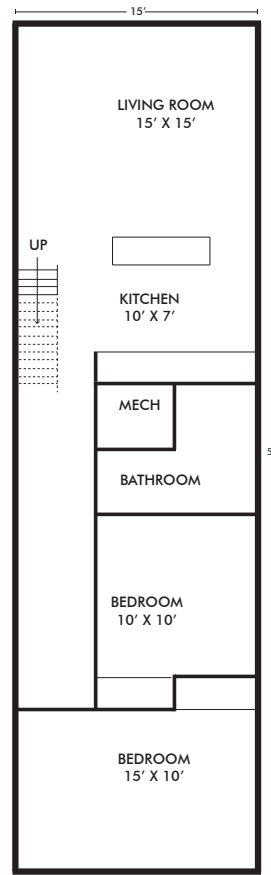

UNIT FLOOR PLAN

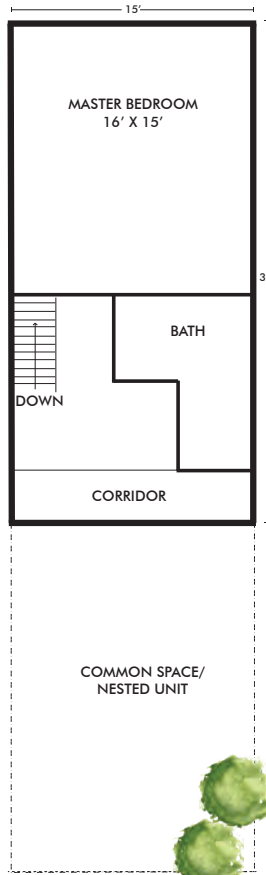

ADDITIONAL UNIT FLOOR PLAN

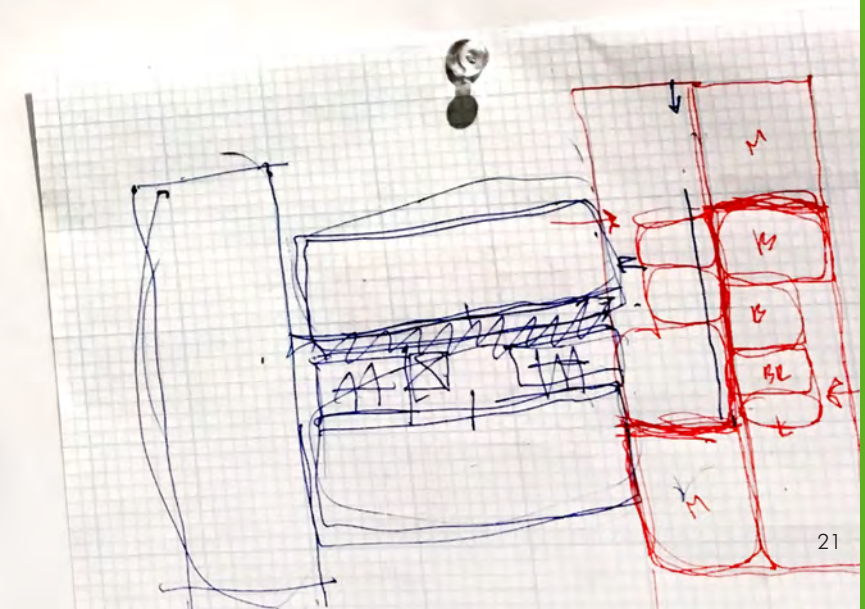
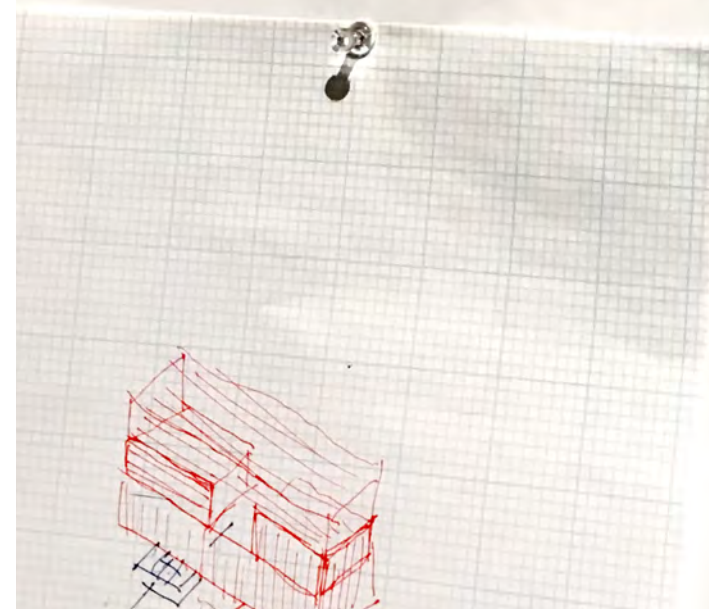
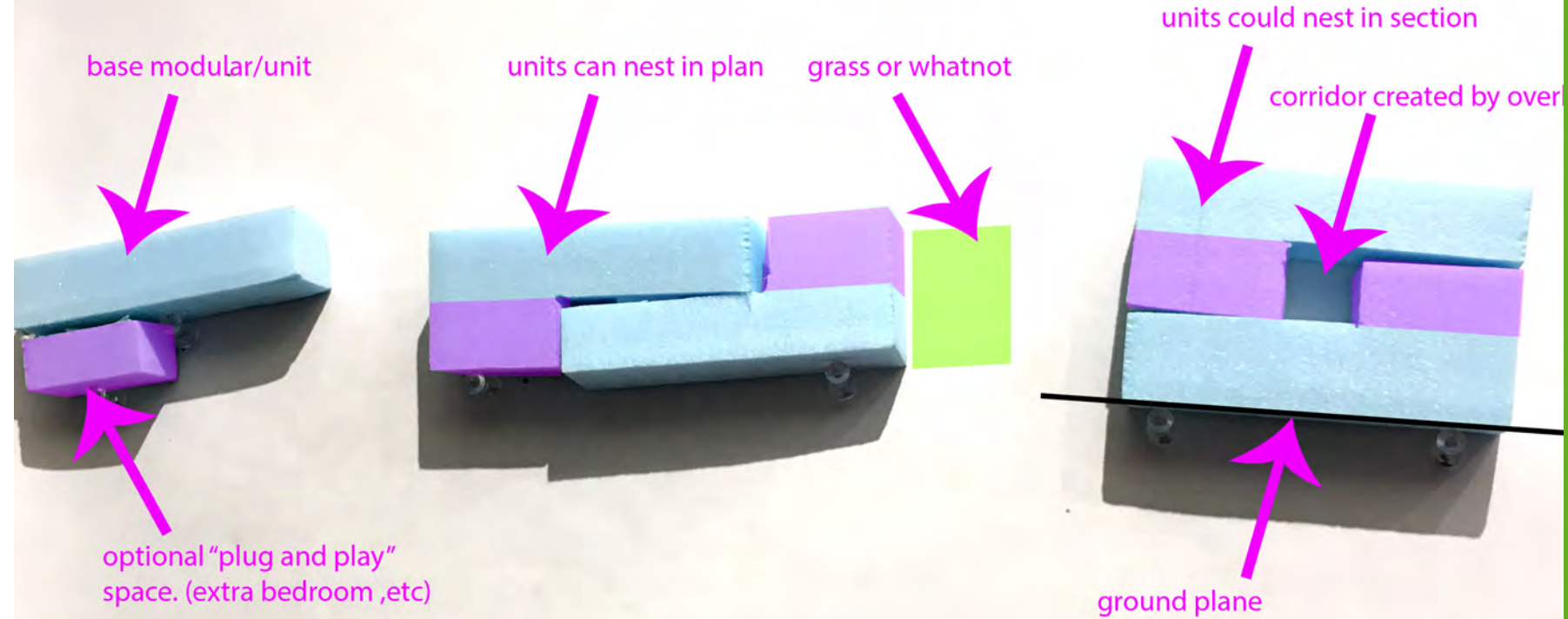

MAKING THE MOST OF LIMITED SPACE

The team explored modular construction for units organized along a double-loaded corridor. Developers favor this typology due to its high efficiency and rentable area per square foot. The team explored and tested the maximum dimensions of the capacity of a truck in plan and in section. The team multiplied the maximum 15'8" transportation width 4 times into two "WET" and two "DRY" prefab units that together, come close to 62' for the width of the building. The layout provides appropriate space for living, sleeping, bathing, and cooking.

Separating trades—plumbers working on the "WET" prefab units and exterior envelope contractors mostly working on the "DRY" prefab units—increases efficiency in the prefabrication plant.

The flexibility in stacking of the "DRY" units allows for private outdoor spaces to be created on top of the unit below without adding another floor construction. This eliminates a portion of the double-floor construction, typical of prefabrication construction. Where the double floor construction remains, a faceted façade creates different living experiences and presents an opportunity to break from the four walls of a box.

TEAM: Sean Cottengim, Stefan Cornelis, Anne Schwab, Chad Burke, Tanvi Shah

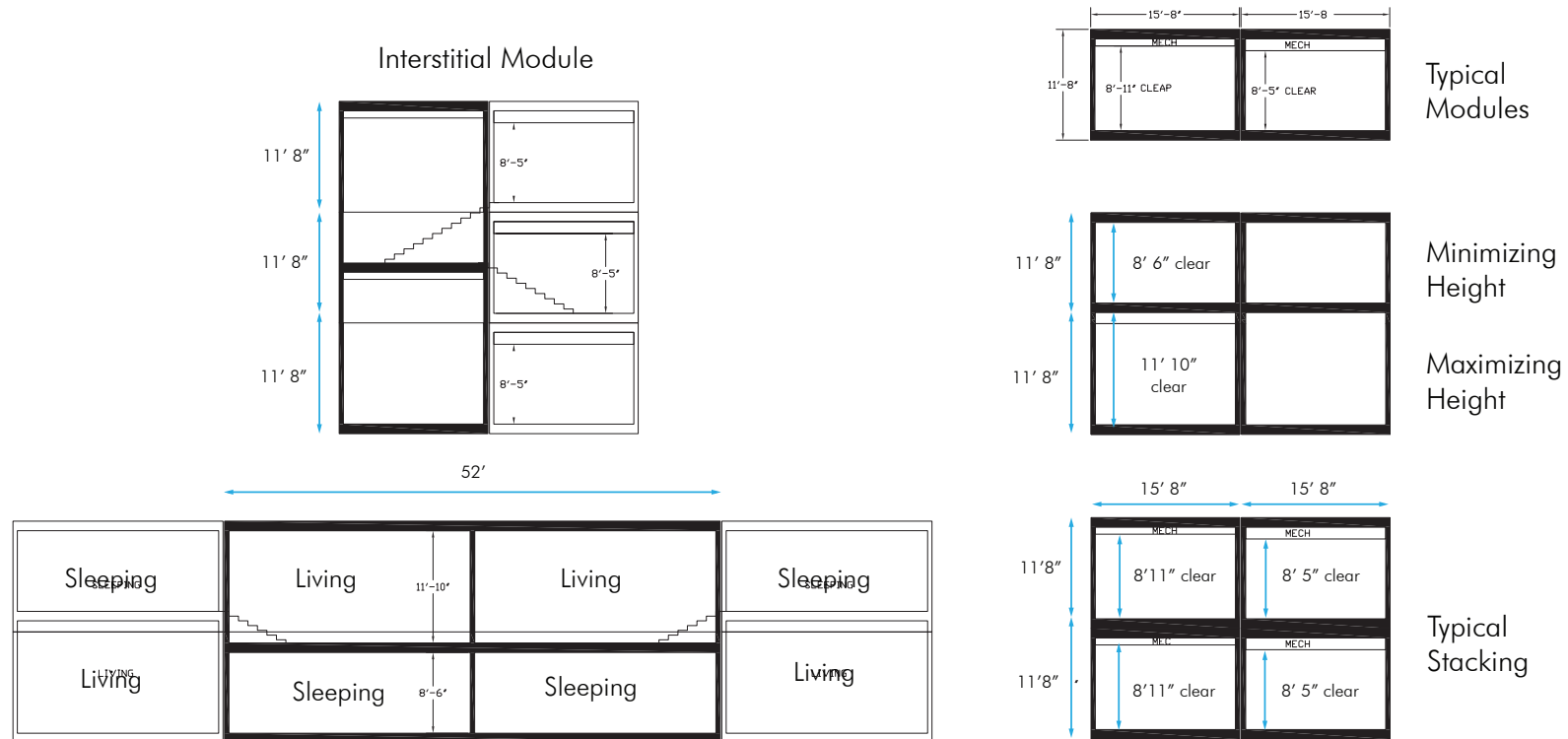

MODULE CONFIGURATIONS



Maximum Truck Length

2 BEDROOM

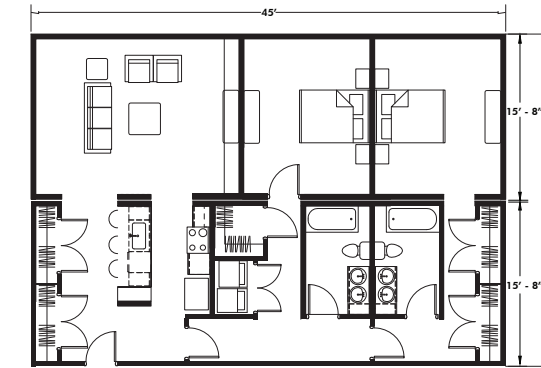

2 BEDROOM + DEN

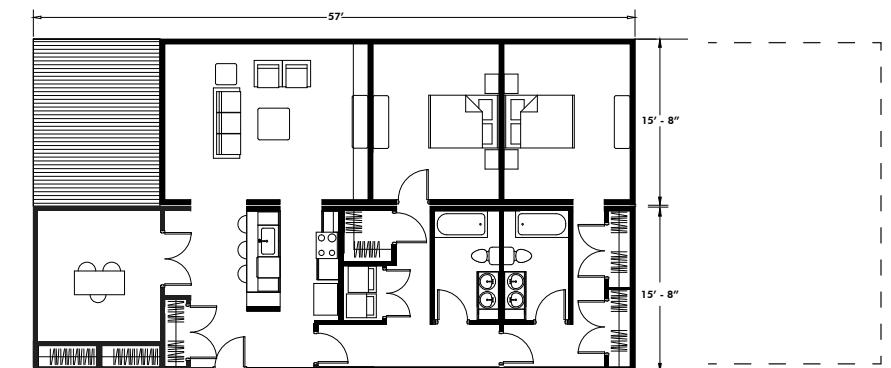

2 BEDROOM + CORRIDOR

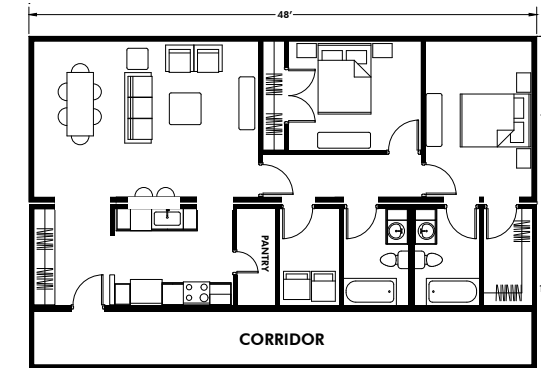

2 BEDROOM + DEN + CORRIDOR

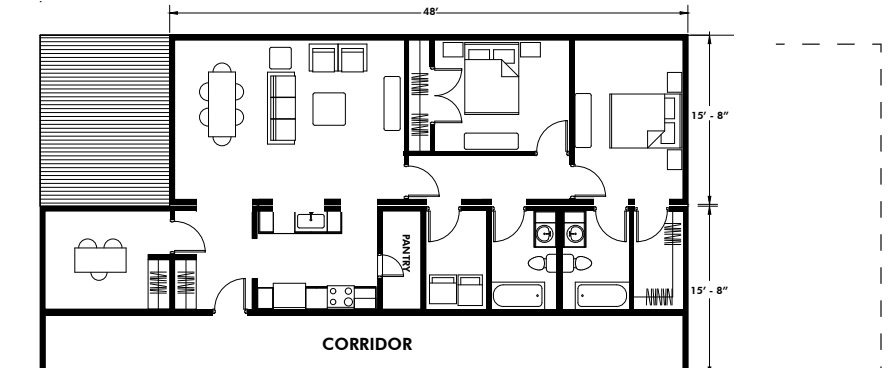

MODULE CONFIGURATIONS (CONT'D)

2 BEDROOM + 1 BEDROOM

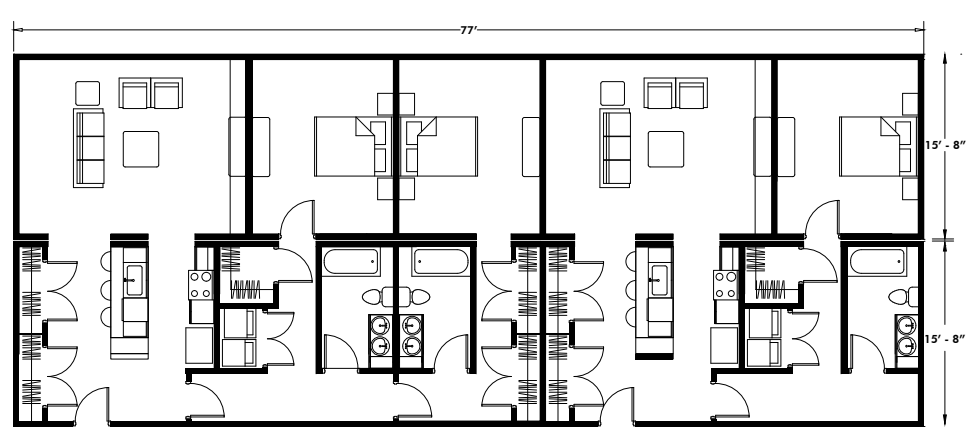

2 BEDROOM + 1 BEDROOM + CORRIDOR

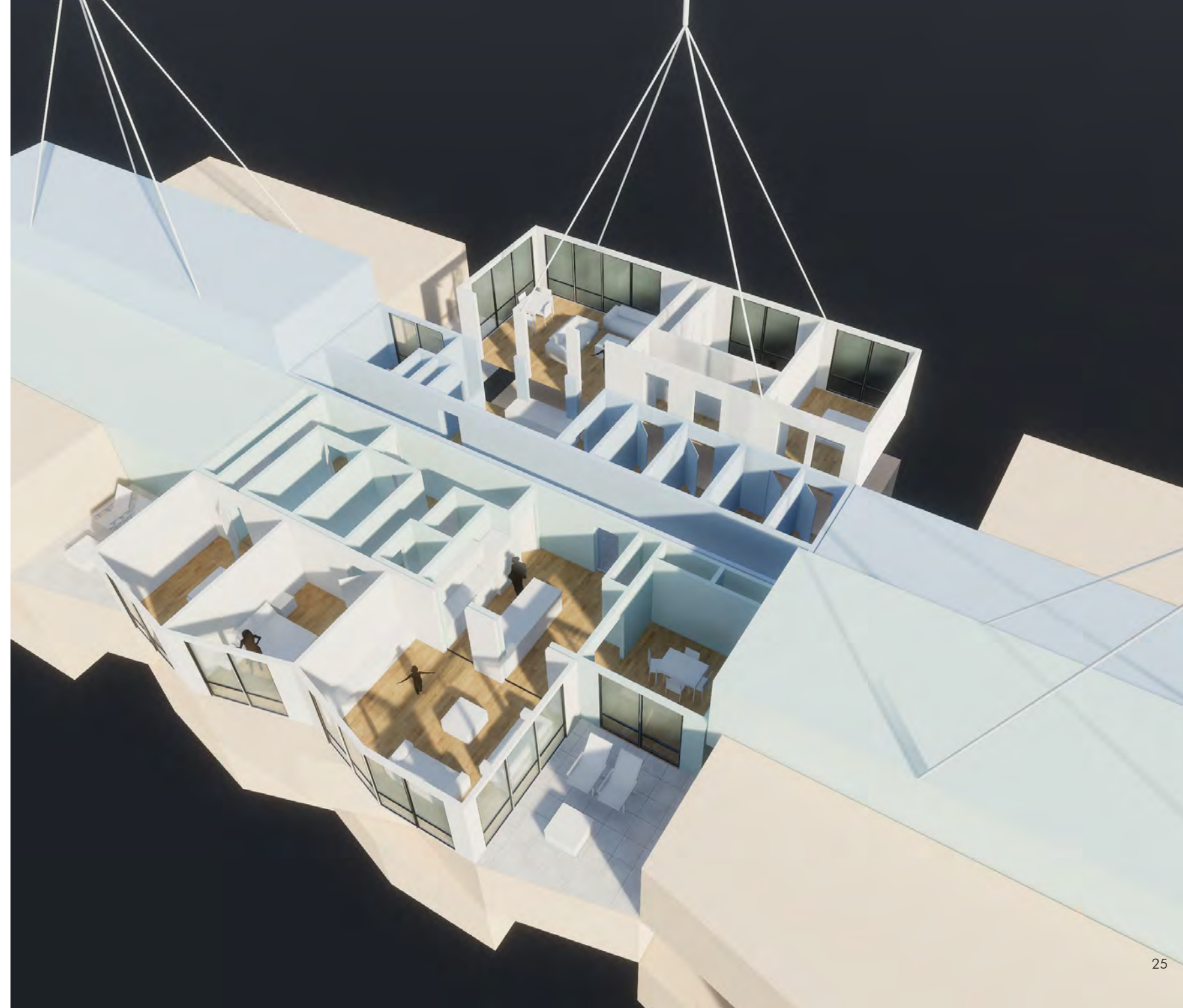
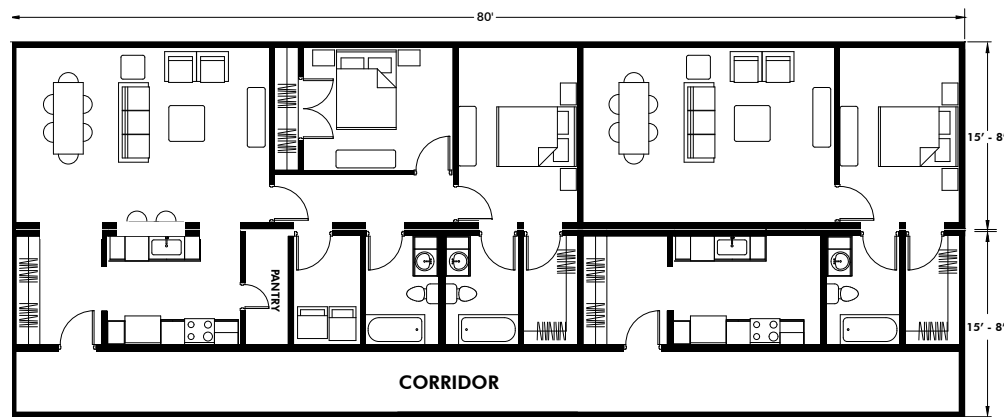

ROOM TO GROW

The core unit is the same for all housing configurations and is completely expandable. Each core unit begins as a studio apartment, but can expand up to a 3 bed/3 bath + den unit, and contract back to a studio if needed. Where connections need to be made between pods, sections of wall are simply punched out.

The building begins as a structural frame with stairs/elevators, lobby and enclosed corridor, with the idea that it will be filled in over time. Homeowners can buy as many empty cells as desired knowing that all cells can be assembled and occupied at a later date—empty cells become private or public rooftop garden spaces.

All units are configured to be shippable using road transport. All pods can be fully furnished prior to lifting into place as well as transported to other buildings with the same structure. Job transfer to Denver? Move your whole house! All finishes are fully customizable. All pods are simply “plugged” into place with fully integrated plumbing/electrical systems.

| Move your whole house!

Team: Mark Lee, Jennifer Sebranek, Michael Reinersman, Jonny Hoffman

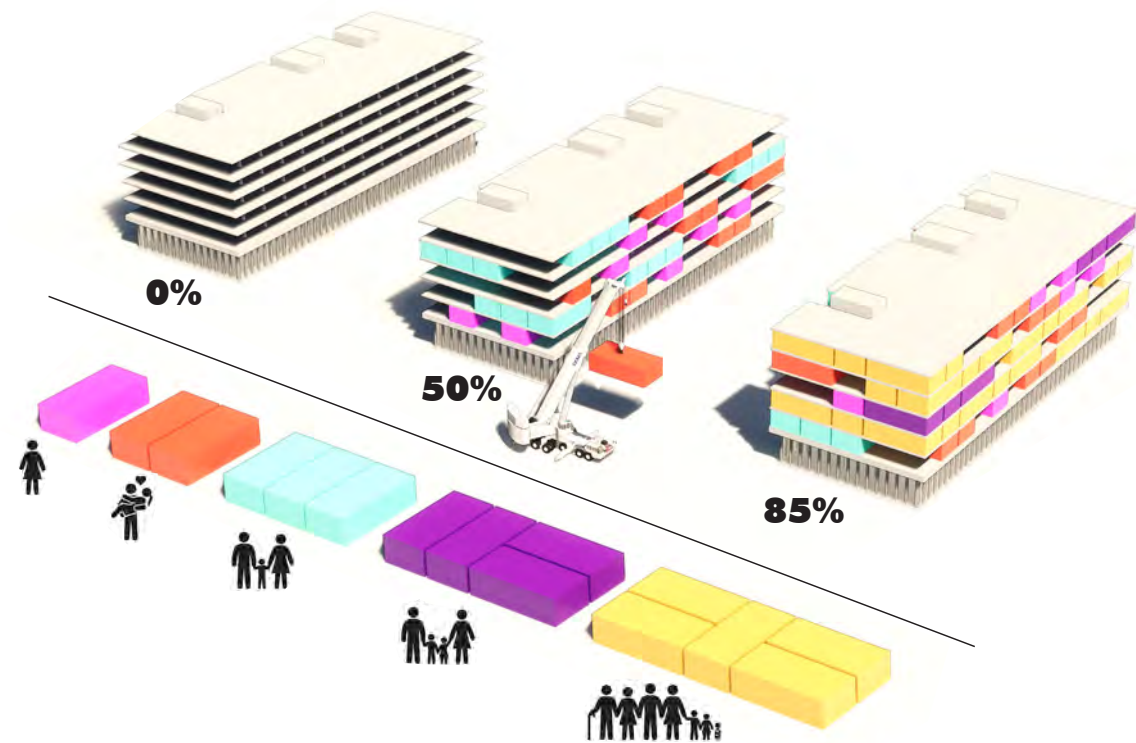

UNIT CONFIGURATIONS

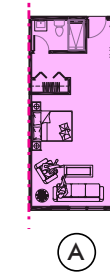

+

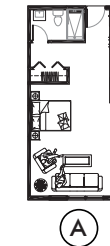

=

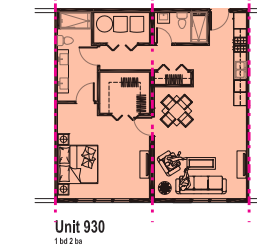

+



+

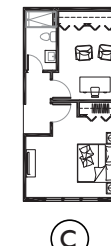

=

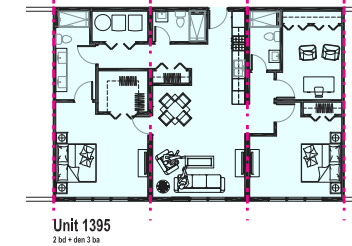

UNIT CONFIGURATIONS (CONT'D)

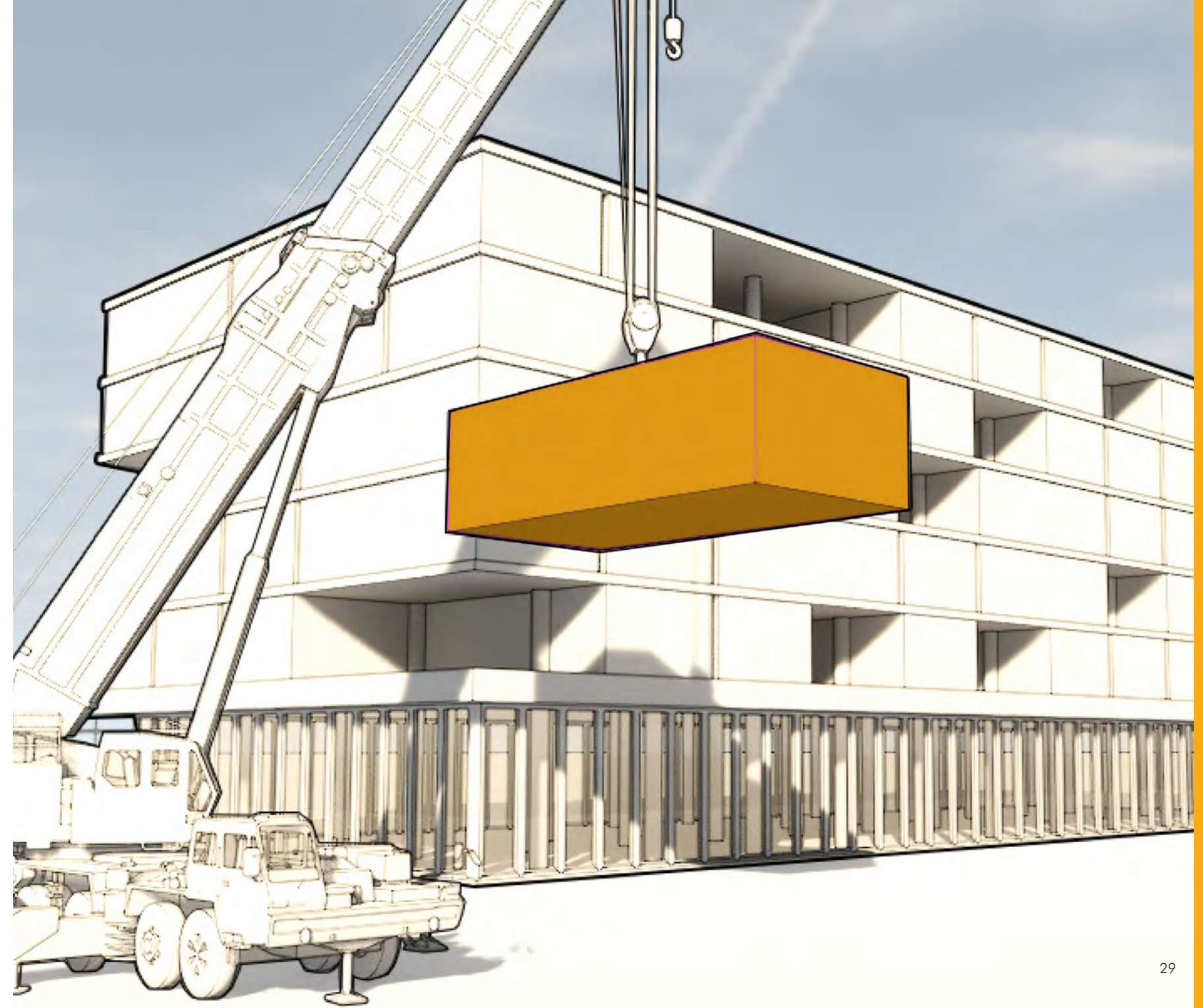
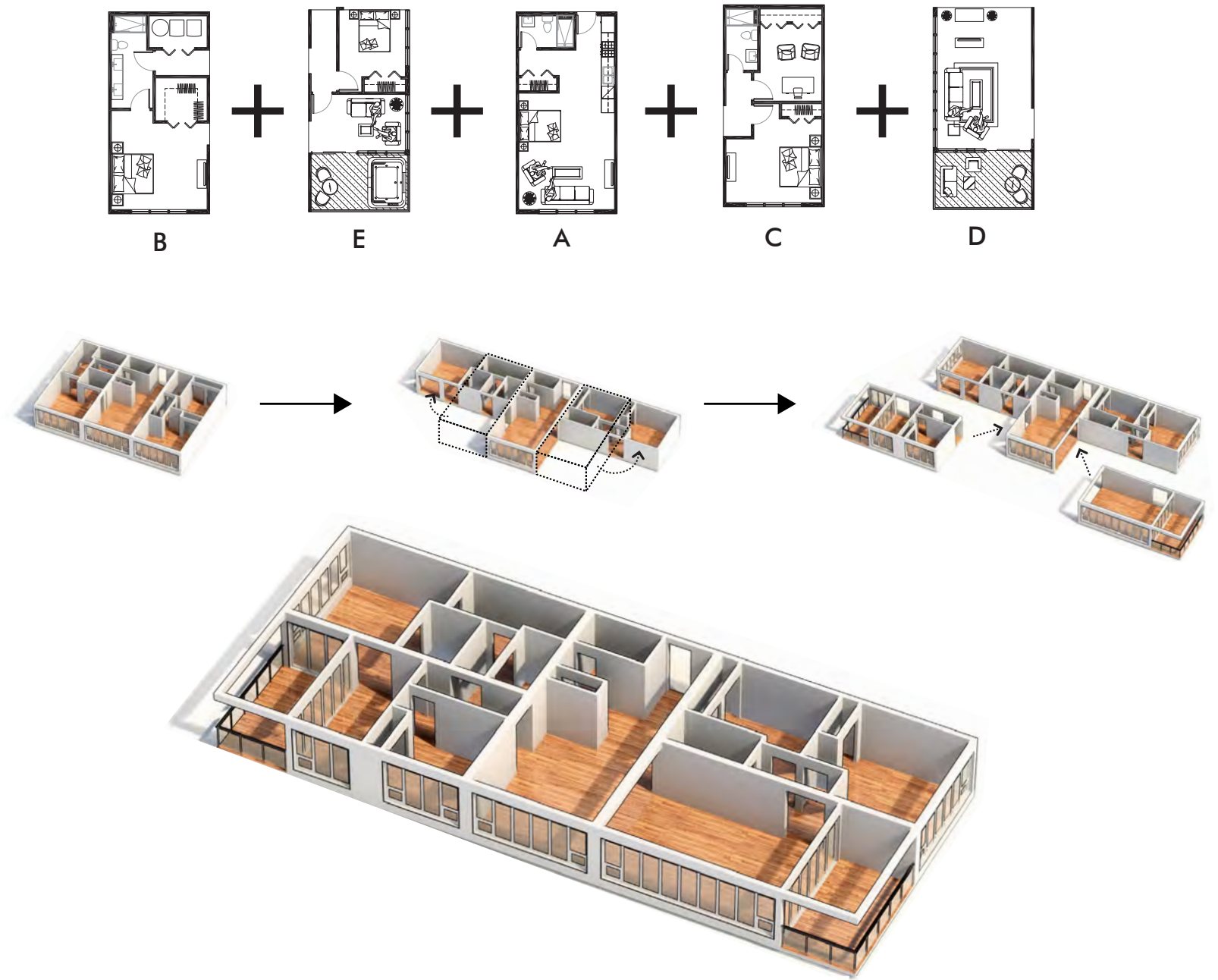

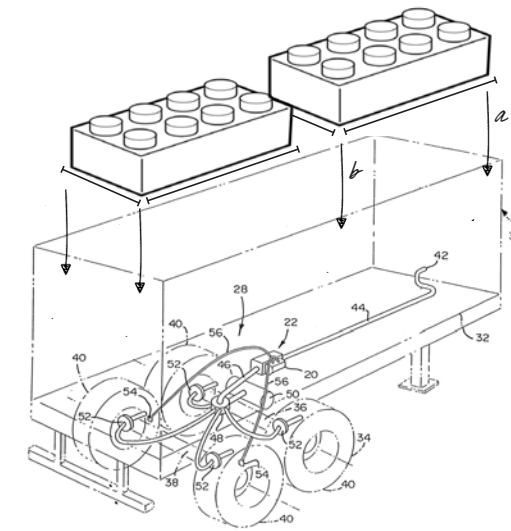

TECHNICAL TACTICS

The Louisville team, along with local members of the modular building industry, explored the techniques, tools, and technology required to craft modules that meet the needs of the users. They also tackled sustainability issues and looked at innovations surrounding transporting modules from factory to building site.

FABRICATION & SHIPPING

Innovation in concrete technology allows lightweight concrete panels to take on new, more aesthetically pleasing forms. Panels are combined with structural steel backing, which supports weight of concrete over large spans. Integrated structural connections enable rapid installation.

Panel incorporates embedded utilities and insulation for minimal work post installation. Steel structure wraps edges of panel to provide lateral stability. Vertical integrated connections attach to floor slabs for rapid installation.

Team: Ted Madden, Stacy Williams, Jason Groneck, Matt Nett, Chris Bowling

INTEGRATED PANELIZATION

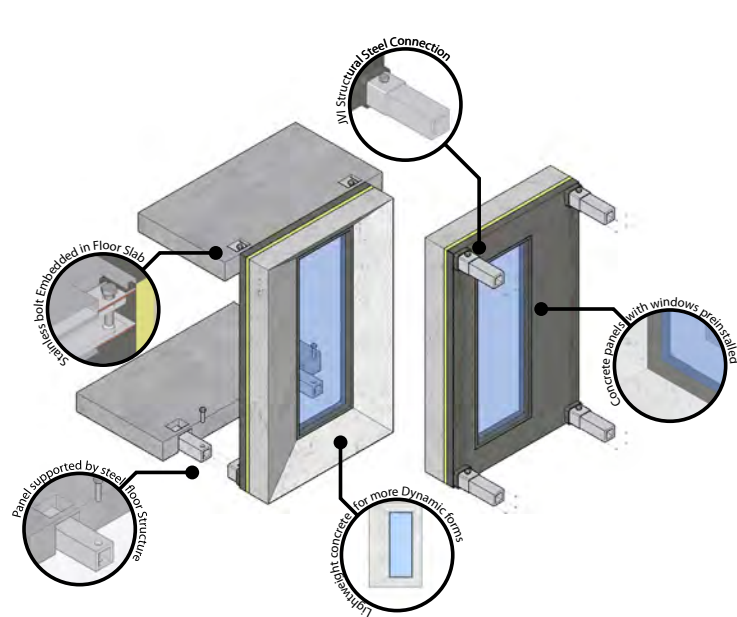

Free Form Concrete Panel

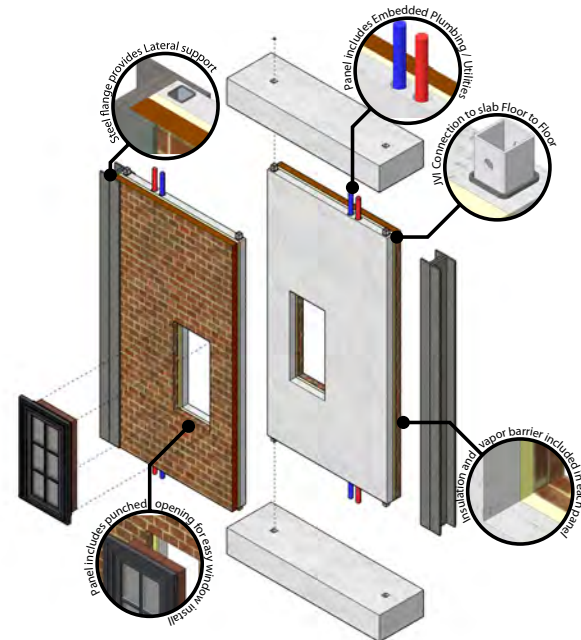

Masonry Panel

SHIPPING

Embracing the advantages of prefabrication goes hand-in-hand with understanding the technical challenges associated with this type of construction. From understanding the "industrial unit" - *the maximum size that one module can be shipped* - to the potential impact on the design process, designers and builders are confronting a new set of issues, but also opening up to many new avenues for innovation in all areas of building. The spectrum spans from labor to facades to structural systems, as well as supplies and logistics.

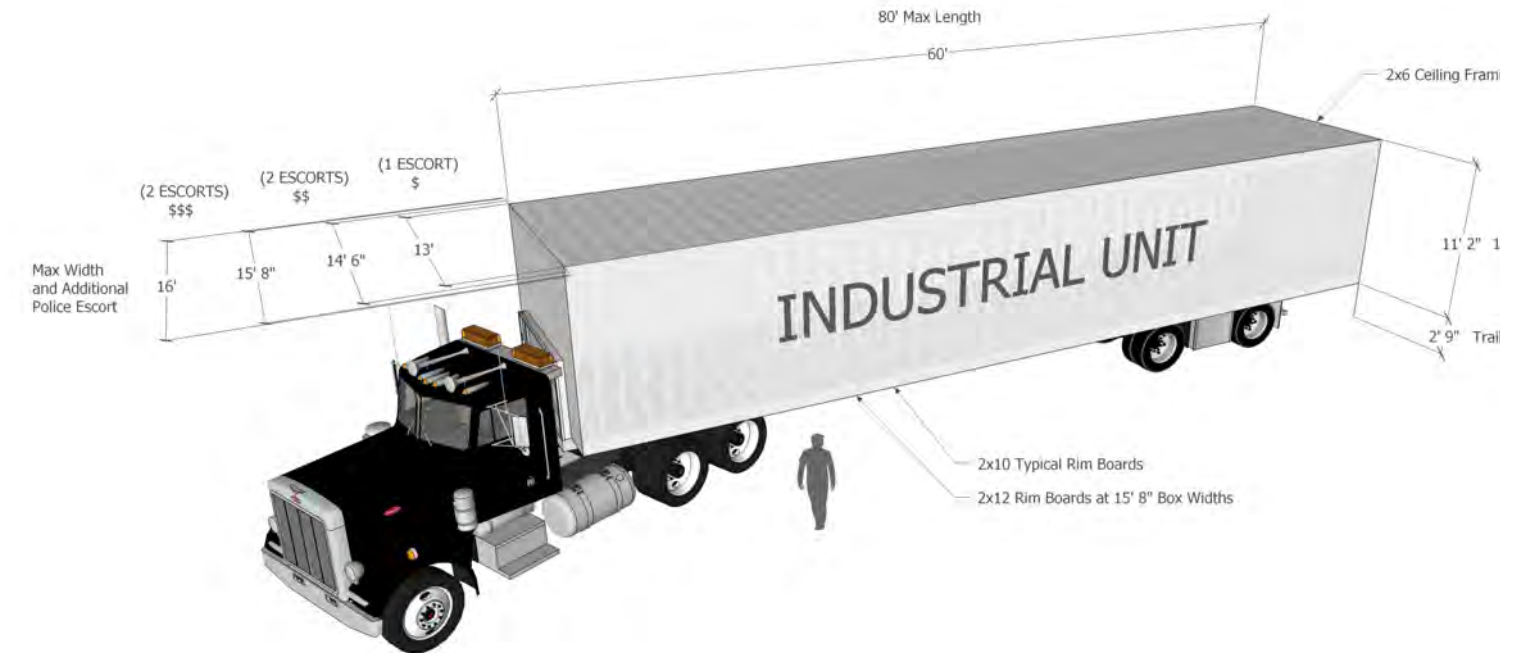

OFF SITE FABRICATION

The benefit of prefabricated elements is that they can be mass produced, and shipped from a single hub. As opposed to traditional construction, prefabrication happens in a controlled environment that allows for constant production and consistent quality. Delivery to site may encounter various legal obstacles, state boundary width maximums, and increased shipping costs.

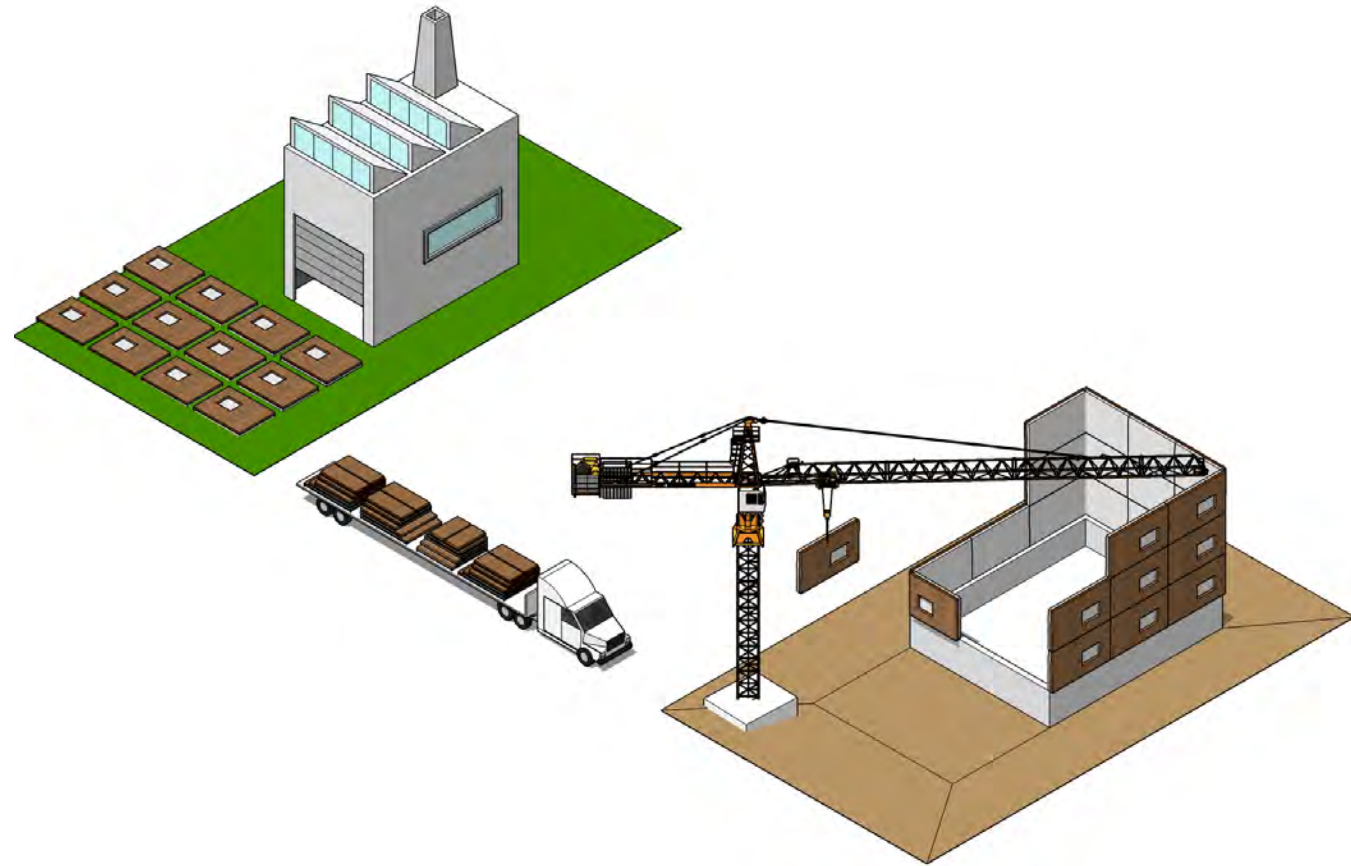

In addition to quality, the stable environment allows for prefabricated elements to be produced in a shorter timeframe. This extra time makes it possible for unique components to be verified in field, built with precision, and easily assembled on site; giving us the ability to employ local labor force native to community. Even the building site itself is afforded more time to better understanding of the conditions.

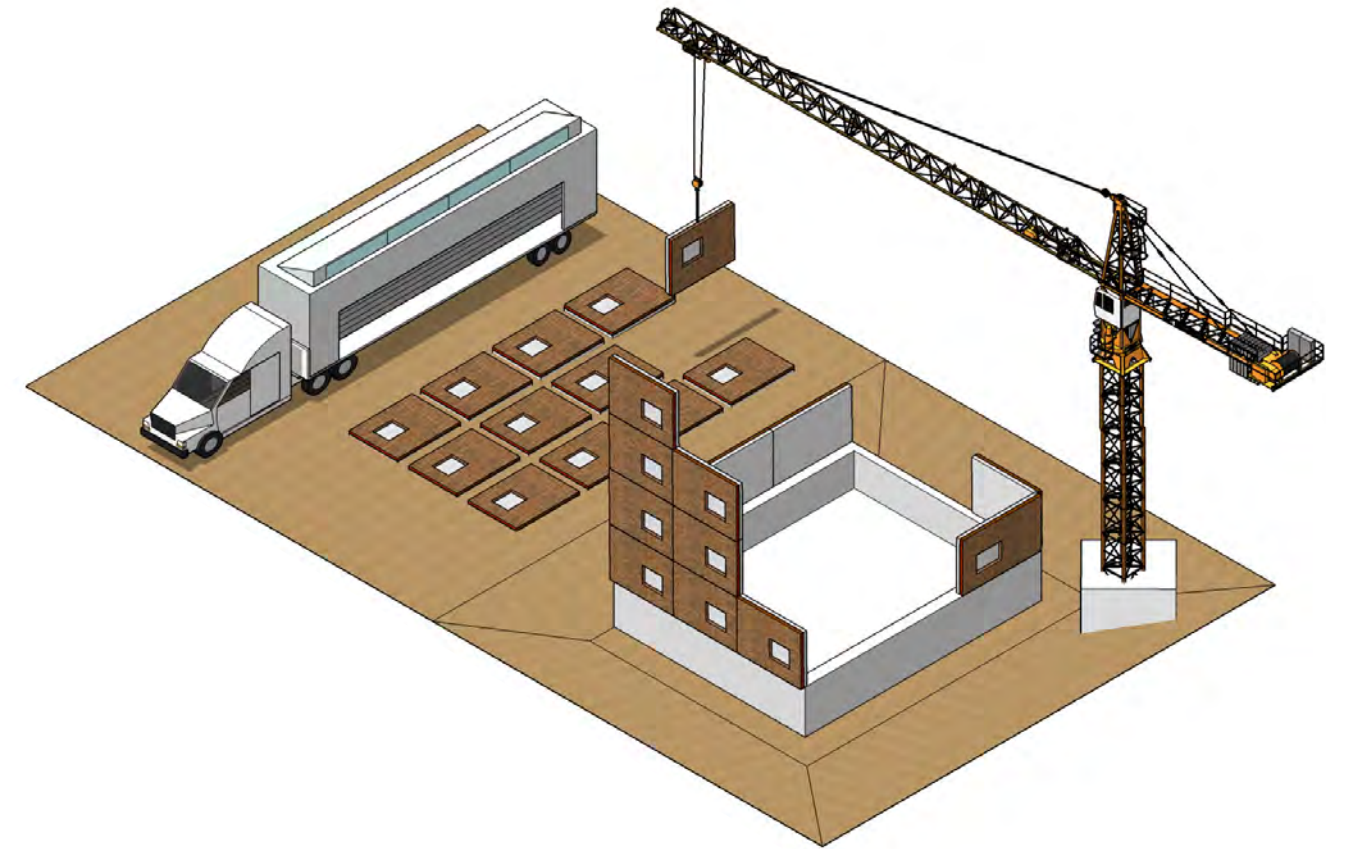

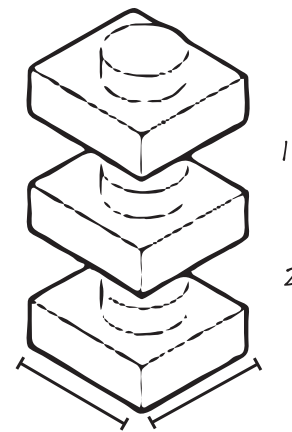

SITE & STRATEGIES

The Pittsburgh team focused on creating a multifamily, mixed-income community on the Hazelwood Green site in Pittsburgh's Hazelwood neighborhood by aggregating modular housing units conceived by the Cincinnati team.

Members of the Hazelwood community were invited to participate in the charrette. The different concerns, thoughts, and ideas of the community members are what drove the development of site specific strategies.

NEIGHBORHOOD

No one building type can make a neighborhood. A diversity of housing, community services, and common green space for ALL make or break its success. With this in mind the group focused on the varied needs of the community.

Team: Lena Andrews, Mick McNutt, Matt Plecity, Phyllis Kim

We discovered a YMCA is needed to replace the one recently closed nearby as well as a Food Hub to train and showcase the growing and cooking of food. To connect outside residents, the bike path centered upon a park space at the end of the Hazelwood Avenue extension bringing additional recreational activities to the site.



LENA ANDREWS
Sr. Development Officer
ACTION Housing

As a Senior Development Officer with ACTION-Housing Lena manages the construction and renovation of affordable and supportive housing throughout the Pittsburgh area. An urban planner by training, Lena is passionate about building diverse, vibrant, connected urban communities. With her team at ACTION-Housing, she has been working in Hazelwood for years on the redevelopment of Second Avenue, Hazelwood's main commercial corridor.

A diversity of housing, community services, and common green space for ALL make or break the success of a neighborhood.

NEIGHBORHOOD SERVICES

As defined in Action Housing's mission statement, "To empower people to build more secure and self-sufficient lives through the provision of decent, affordable housing, essential supportive services, asset building programs, and educational and employment opportunities," Lena Andrews focused the energies of the group beyond an aggregation of prefab housing modules towards the neighborhood services, which support the new and old inhabitants of Hazelwood.

FOOD →

- WORKFORCE
- COOKING INCUBATOR
- GROCERY
- URBAN FARMING

GREEN SPACE →

- BIKE PATH

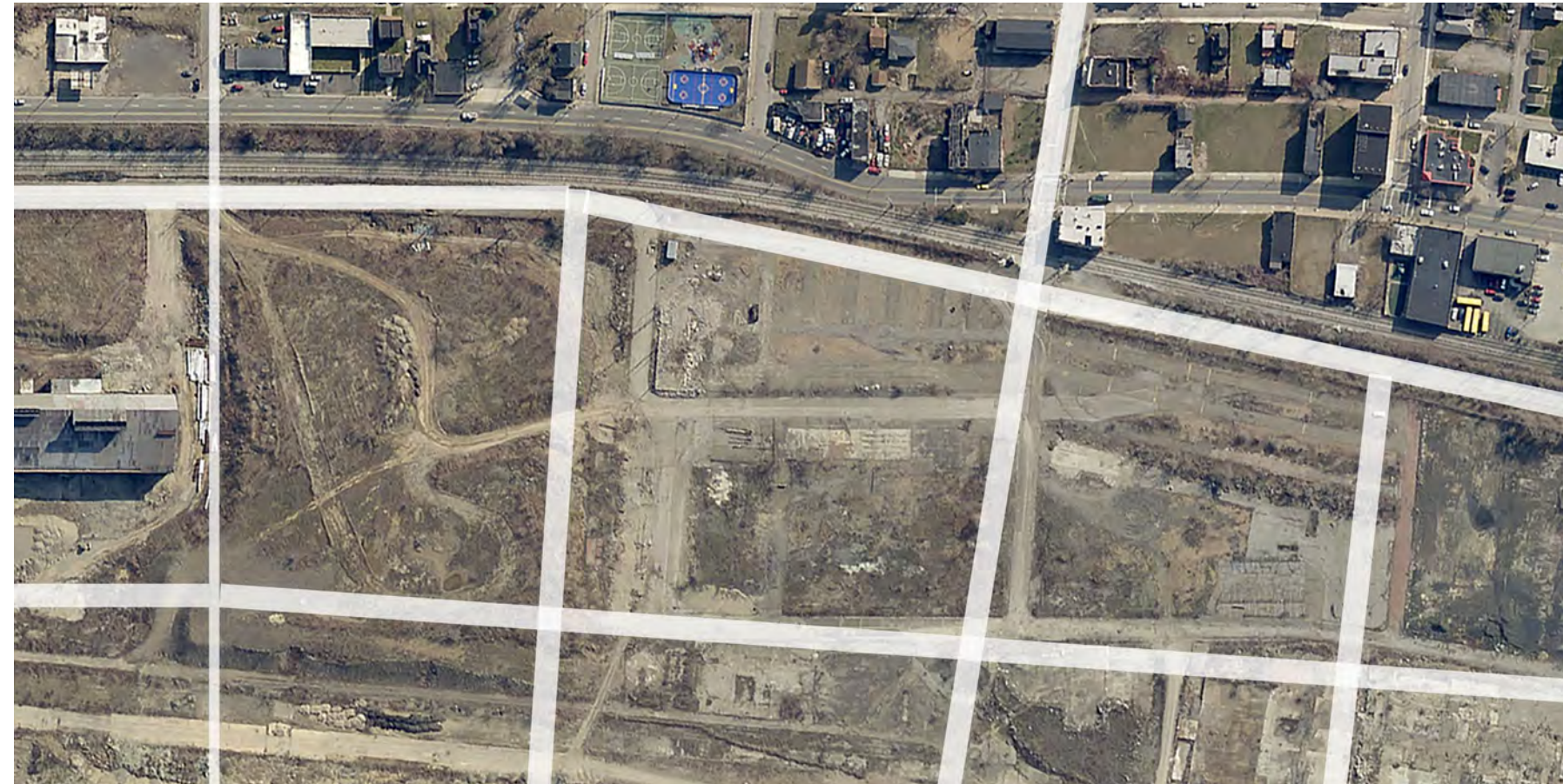

Services bridge new and existing neighborhood.

Hazelwood STUDIES

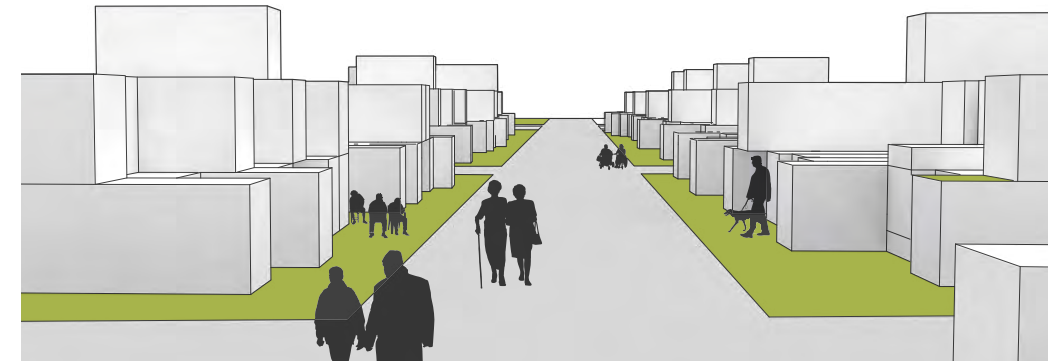

BLOCK

Block by block, the city fills its street grid. By honoring the form and scale of the past city, new innovations in building can provide access to light, air and social activity.

Team: Michael Barnard, Anne Chen, Matt Conti, Stephen Mrdjenovich



MICHAEL BARNARD
Project Director
Oxford Development Company

Michael has been working with clients and teams to oversee the complete building process to deliver exceptional and sustainable working and living environments. He is currently serving as the owner's representative for Pittsburgh's 178-acre brownfield redevelopment, Hazelwood Green (Previously the Almono site).

DEVELOPMENT AMENITIES

Michael and the Oxford Development Company look to bring amenities ideal to Almono development. Paired with the vision to push the boundaries of modular construction, the objectives for the group were defined as follows:

- Optimize prefabricated and modular construction efficiencies.
- Create a building that expresses and celebrates its modularity while still leaving room for the individuality of the inhabitants.
- Reallocate the efficiencies gained from modular and prefabricated construction to the development of amenity spaces, in and around the buildings.



Hazelwood Green

BREAKDOWN & STUDIES

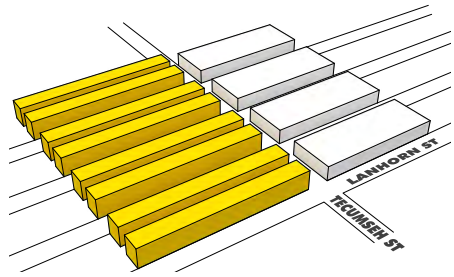

Extension Of Urban Grid

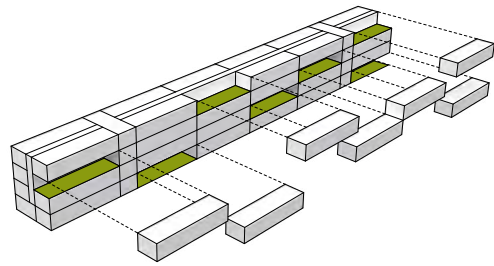

Subtraction - Creates Amenity Space

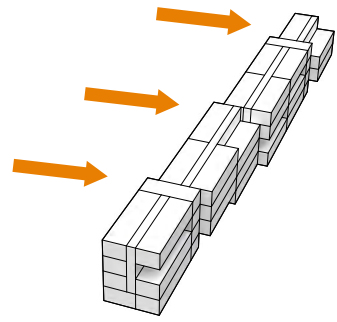

Offset - Shapes Exterior Space

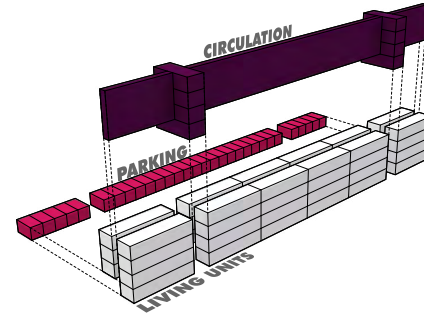

Circulation/Parking/Units

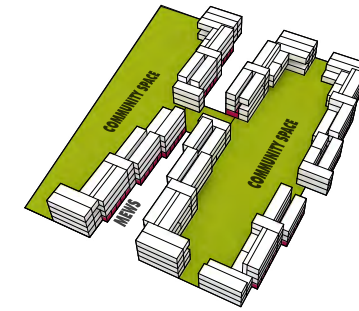

Garden City + Muses

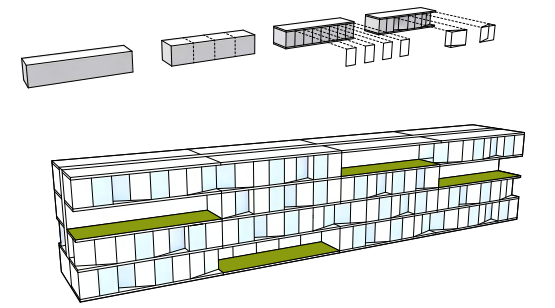

Facade Studies



**PUBLIC GREEN SPACE
& HOUSING BEYOND BLOCK**
HAZELWOOD GREEN, PITTSBURGH

LOT

As the individual units of ownership, the way lots are filled and address the street become the true face of the neighborhood. To create a seamless city, the line between old and new needs to be blurred. Infilling existing vacant lots is as important as the new development site

Team: George Thomas, Daniel Colvard, Melanie Ngami



GEORGE THOMAS

Director of Community Relations
Jackson Clark Partners

George Thomas is a Director of Community Relations at Jackson Clark Partners working in partnership with the Forbes Funds to build a model for sustained resident participation throughout our region. Previously a long-term unemployed veteran, he was hired in 2013 for the Hazelwood Community Census Team.

Although a lifelong resident of Hazelwood, he hadn't been involved in the community and didn't know that neighborhood organizations and local service providers existed. He went from not knowing what was up to people calling him Mr. Hazelwood when he walked down the street. Now, he is a resident outreach trainer for the One Northside Census, Team Leader for the Allegheny Dwellings resident survey, and serves as board vice-chair for Hazelwood Initiative.

RECREATING DENSITY WITH INFILL

As Board Chair for Hazelwood Initiative, George Thomas brought a view of everyday life to the development of pre-fab in the existing Hazelwood fabric. As a lifetime resident of Hazelwood, George concentrated the group on his street, Flowers Avenue. The group sought to define the infill of empty lots with modular units to invigorate the existing fabric with owned, adaptable community space that preserves and enhances the identity of the neighborhood. The space of the street is enhanced by the different ways houses and open spaces address the public realm.

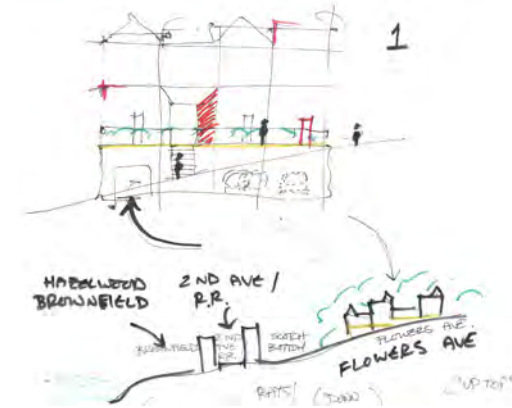

Flowers Avenue

STUDIES

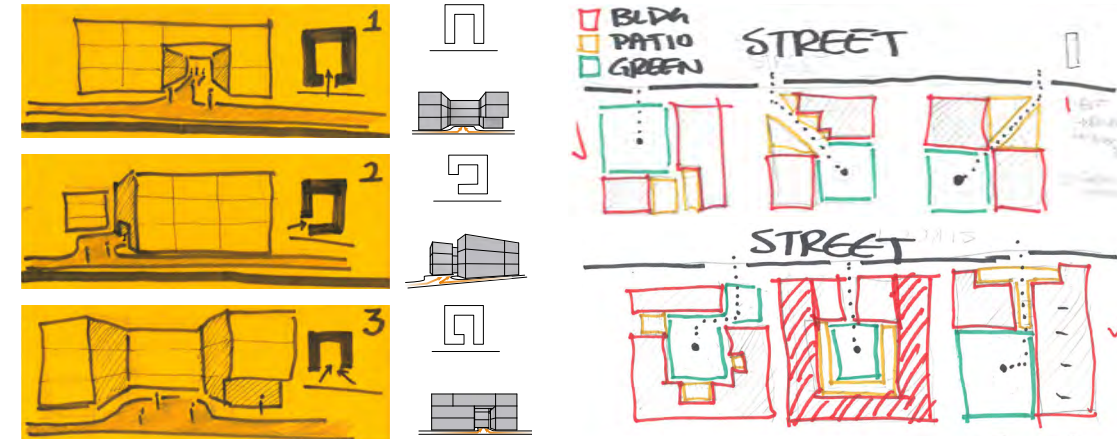

FOOD HUB, PLAZA, & HOUSING
FLOWER ST., PITTSBURGH

URBAN

This group focused on how to express the overall character of the neighborhood. What makes a place recognizable? How can materiality speak to the neighborhood's heritage and identity and how can this be incorporated into new development so that character crosses over.

Team: Dave Brewton, Lowell Day, Melissa Dulisse, Amanda Markovic



DAVE BREWTON

Director of Real Estate
Hazelwood Initiative

Dave helps community-based non-profits increase their capacity to positively impact their neighborhoods in housing and economic development. He uses his talents to physically transform corners of the city of his hometown, Pittsburgh, PA.

In partnership with Rebuilding Together Pittsburgh, the Hazelwood Initiative has worked towards stabilizing and improving the neighborhood's housing stock through free and discounted home repairs to help homeowners maintain the value in their homes. The Hazelwood Initiative is also involved in the development of Hazelwood Green, ensuring that it meets the highest possible sustainability standards and maintain a growing diversity (economic, ethnic, age, race and orientation).

NEW IN THE OLD, OLD IN THE NEW

The group focused on getting the new in the old and the old in the new. The downfall of most modern urban developments is that there is a distinct line between the existing and new fabric, and that often also relates to economic lines. Our strategy is to blur those lines by providing, as part of the development, new construction as infill within the existing neighborhood.

The development within the large vacant site will include elements commonly seen in the Pittsburgh 'hodgepodge' neighborhoods such as gabled roofs and materials such as brick, wood and steel. This rich fabric will create a vibrant community with pedestrian-friendly streets and open spaces drawing people through the site to the riverfront.



Hazelwood Green abuts existing neighborhood

BREAKDOWN & STUDIES

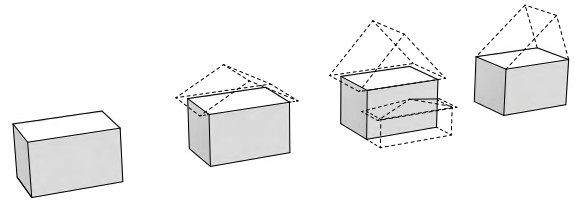

BUILDING STYLE + IDENTITY

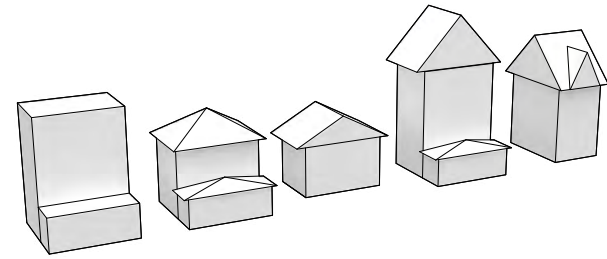

NEIGHBORHOOD CHARACTER

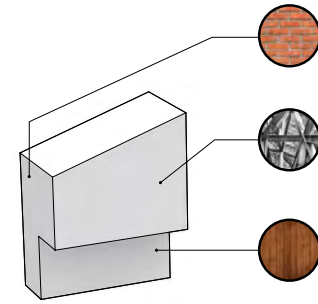

MATERIALS

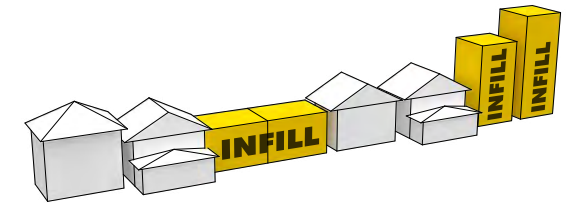

SCALE + DENSITY

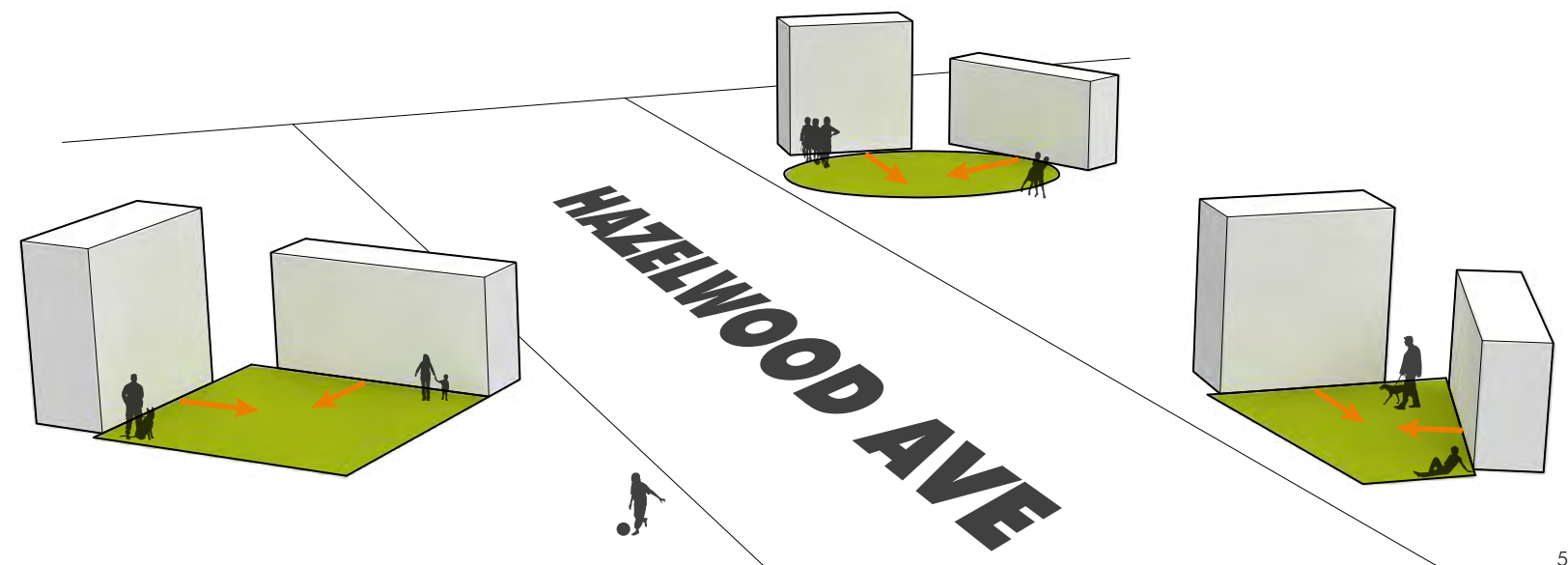
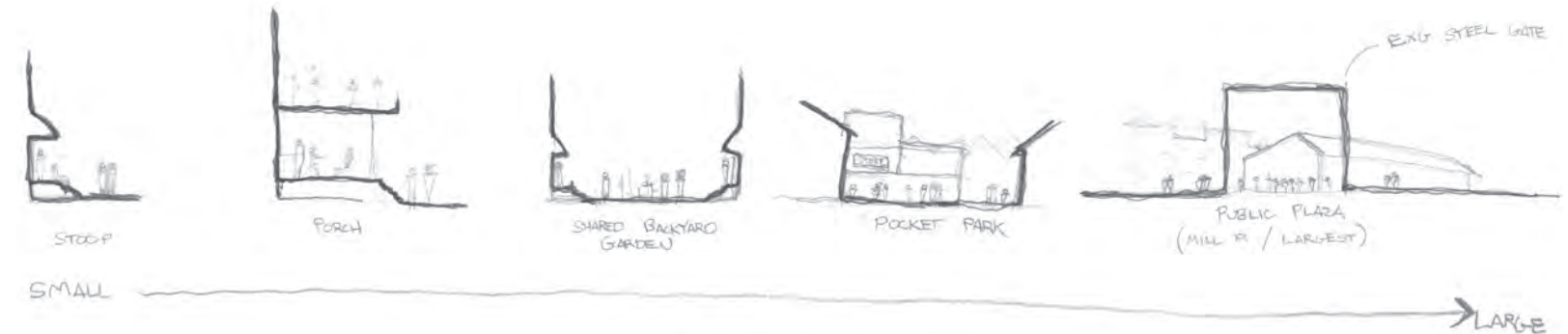

As an alternative construction delivery model, GBBN has taken the opportunity to complete a selection of prefabricated and modular building projects.

IN ACTION

1. Vanke Xinyuan
2. Tree Pittsburgh
3. St. Ambrose Apartments
4. The Edge on 4

VANKE XINYUAN

In 2004, GBBN worked with Vanke, one of the world's largest real-estate companies, to help them create a prefabrication strategy that could address the high paced housing demand without compromising quality. They wanted to manufacture an entire building from standardized components that could be manufactured in one or two locations and shipped to building sites throughout China.

GBBN showed them how they could create a sense of variety within a consistent plan language.

We found that prefabrication wasn't a limitation to design quality or design language. The use of components, while if you isolated them, would look rather repetitive, we were able to have it become an asset.



TREE PITTSBURGH

GBBN is working with Tree Pittsburgh-- a non-profit organization dedicated to protecting and growing the urban forest--to develop the design for their riverfront campus above the Allegheny River on the site of a former steel mill.

Sustainable design elements include rainwater collection, the utilization of renewable energy sources, and modular prefabricated construction, which cuts down on construction waste.

Shipping modules to the job site is major consideration when working with prefab; height and weight requirements mean module manufacturers must be engaged early in the process.

“Prefab is definitely more sustainable. It’s built in a controlled environment, where it’s not raining or snowing, and quality control is much better and happens on a more predictable time line.”

Matthew Plecity
Designer
GBBN

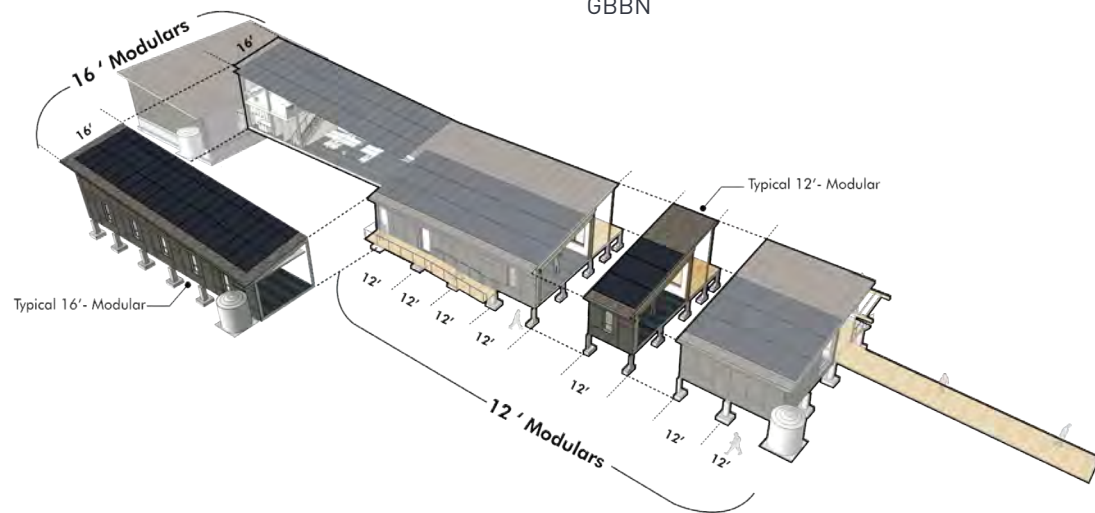

ST. AMBROSE APARTMENTS

With a tight schedule of demolition, site preparation, and new construction, GBBN investigated the use of modular construction for this project, which was originally conceived as a renovation.

Working with Model Group and Unibilt, GBBN designed a three-story structure of one and two bedroom flats, and eight two-story town homes. The flats are arranged around a courtyard with common stairs and an elevator using traditional construction.

The apartments are delivered with all finishes, cabinetry, appliances and installed doors and windows—are placed on conventional foundations. Brick and siding facade materials are designed to fit into the context of the neighborhood.

“Most of the construction happened in an off-site factory during the region’s infamous *Polar Vortex* in the winter of 2013, which caused many *other* projects to have significant delays.”

Steve Kenat
Community Development Director
GBBN



THE EDGE ON 4

The Edge on 4 is a residential development for Capital Investment Group. The project will add 232 residential units in downtown Louisville between the nightlife surrounding 4th Street Live and the theater and music scene of the famous Louisville Palace Theatre.

As a vital link between two destinations, the project aims to create a safe and engaging pedestrian experience that is scaled right, rich in materials, and contextually appropriate to the urban fabric of one of Louisville's most important historic commercial streets.



The Edge on 4 uses a pre-engineered, prefabricated framing system. Studs were incorporated into factory made panels which were then erected on-site in less time than typical on-site framing construction, allowing the finished project to come to market sooner.

“With prefab and modular you have to understand the restrictions and work within them. But some of the best architecture comes with the most restraints.”

Chris Bowling
Architect
GBBN





SHOW & TELL

The work of Pre Fab Lab culminates in an exhibit held in each of GBBN's U.S. offices. Free and open to the public, it's our chance to share our findings with our AEC peers and members of the community.

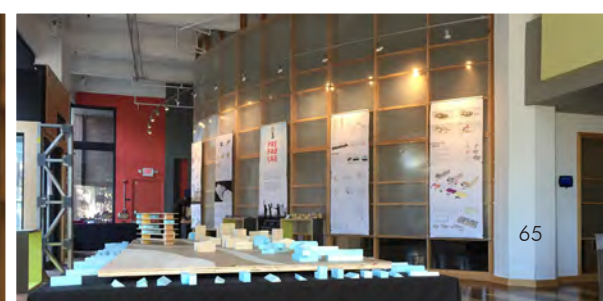



WHAT WE LEARNED

While prefabrication may have limitations, as architects we choose not to be limited by them. By reallocating efficiencies gained from modular prefabrication, amenity spaces, both in and around the buildings can be more thoughtfully addressed. We think modular construction can be the catalyst to increasing affordable, well-designed housing quickly to those who need it now. By providing quality housing through modular and prefabricated construction, focus can turn to shared amenity spaces, enhancing the social success of the people that live there.



:PRE FAB LAB